



Gas Detection  
Tubes and Sampling  
Handbook



# Table Of Contents

1. INTRODUCTION.....	3
2. QUALITY ASSURANCE PROCEDURES.....	5
3. OPERATION OF DETECTION TUBES AND PUMPS .....	7
3.1 Hand Pump Description.....	8
3.2 Tube Measurements.....	8
3.2.1 Tube Description and Packaging.....	8
3.2.2 Testing Hand Pump for Leaks .....	10
3.2.3 Measurement Procedure.....	10
3.2.4 Reading Tubes.....	13
3.3 Maintenance of the LP-1200 Piston Hand Pump.....	14
3.4 Selection of Sampling Pump.....	15
3.5 Operation and Maintenance of Remote Sampler.....	15
4. TECHNICAL INFORMATION .....	19
4.1 Theory of Operation.....	19
4.2 Explanation of Data Sheets .....	20
4.3 Humidity, Temperature, Pressure and Matrix Effects .....	22
5. DATA SHEETS FOR GAS DETECTION TUBES .....	26
6. SPECIALTY TUBES .....	103
6.1 Smoke Generating Tubes .....	103
7. APPENDICES .....	105
7.1 Appendix 1. Alphabetical Tube List.....	105
7.2 Appendix 2. Tube List by Part Number .....	107
7.3 Appendix 3. Detectable Compounds.....	109
7.4 Appendix 4. Equivalent Tubes of Other Manufacturers.....	114
7.5 Appendix 5. Conversion Factors for Gas Concentrations.....	117
7.6 Appendix 6. Humidity Conversion Tables.....	118
7.7 Appendix 7. Warranty.....	119
7.8 Appendix 8. Honeywell Analytics Contacts .....	120

**WARNING**

The products described herein will perform as designed only if they are used, maintained, and serviced in accordance with the manufacturer's instructions. Failure to use, maintain, and operate products properly can result in dangerously inaccurate readings.

**CAUTION:** For safety reasons, the equipment described herein must be operated and serviced by qualified personnel only. Read and understand this instruction manual completely before operating or servicing.

**ATTENTION:** Pour des raisons de sécurité, ces équipements doivent être utilisés, entretenus et réparés uniquement par un personnel qualifié. Étudier le manuel d'instructions en entier avant d'utiliser, d'entretenir ou de réparer l'équipement.

## Custom Tubes

Please contact Honeywell about the availability of custom tubes not included in this handbook. Contact information is included on page 128.

## Application & Technical Notes

Honeywell's web site includes the Application Notes and Technical Notes cited in this handbook, as well as many others. Visit our web site at: [www.honeywellanalytics.com](http://www.honeywellanalytics.com).

© 2014 by Honeywell International. This handbook is fully protected by copyright, and no part of it may be reproduced in any form without the express written consent of Honeywell, 3775 N. First St., San Jose, CA 95134-1708 USA.

# 1. INTRODUCTION

This handbook describes the use and performance of gas detection tubes and sampling pumps manufactured by Honeywell. Honeywell began manufacturing gas detection tubes in 1997 and is adding many new tubes to its product line each year. Modern production facilities and techniques allow us to offer high-quality tubes at a highly competitive price.

Gas detection tubes operate in the following manner: An air sample is drawn through a tube containing a reagent, causing a color change. The concentration is then read from the length of the color stain in the reagent. The advantages of detection tubes over other analytical methods are simplicity of use, rapid response, low cost, and very low maintenance. Because each batch of Honeywell tubes is pre-calibrated, no calibration equipment is necessary. Errors are prevented by directly marking the calibration information on each tube, and accuracy is further ensured by controlling the volume of air sampled. Honeywell tubes are primarily of the narrow bore type and are designed for use with a Honeywell hand-operated piston pump.

Air sampling can also be performed using piston pumps, which latch into a precisely defined position to fix the volume. These pumps pull a strong vacuum initially and thus create substantially higher flowrate than the bellows pumps. Piston pumps generate a high flow initially followed by an approximately exponential decay, whereas bellows pumps provide a more steady flow initially followed by the slow decay. The difference in flow patterns means that the pumps cannot be interchanged between types. For example, piston pumps sometime cause a smearing of the color stain when used on tubes originally developed for bellows pumps. This occurs because the higher flow rates do not allow enough contact time to give sharp endpoints when a piston pump is used.

For a period of time, attempts were made to improve accuracy by stabilizing the flow rate using rate-limiting orifices. Some manufacturers supplied as many as four different orifice sizes to match the particular tube being used. However, exchanging limiting orifices proved to be cumbersome and unnecessary as long as enough contact time was allowed to avoid smearing the stain. Therefore, limiting orifices have fallen out of use and it has now become standard practice to build the flow restriction into the tube itself. This is done by selecting the particle size of the support material and type of end plug that give a sampling time appropriate for the particular chemical reaction of the tube.

As a result of these developments, modern tube/pump systems have stabilized into two categories: (1) low-vacuum bellows pumps with less flow resistance in the tubes, by virtue of being wider (~7 mm o.d.) and having larger particles, and (2) high-vacuum piston pumps with greater resistance in the tubes by being narrower (~5 mm) and having smaller particles. The bellows pump/tube systems tend to have faster sampling but require more pump strokes to complete a measurement, whereas the piston pump systems generally need fewer strokes but longer sampling time per stroke. Honeywell tubes are primarily of the narrow-bore type and are designed for use with a piston sampling pump.

## 2. QUALITY ASSURANCE PROCEDURES FOR GAS DETECTION TUBE MANUFACTURE

All Honeywell gas detection tubes are developed in an ISO 9001 certified facility and manufactured in an ISO 9001 certified factory. All procedures, work instructions, and quality records are documented and maintained to ensure tube quality. The procedures are outlined below.

- A. Tube Selection.** Glass tubing is selected to fit a standard bore size to ensure uniform length of color change.
- B. Support Preparation.** Silica, alumina, and other support materials are chosen from the highest quality available and sieved to yield a narrow particle size distribution. The supports are then further purified as necessary and dried to well-defined levels depending on the requirements of the tube reactions.
- C. Reagent Loading.** Chemicals are chosen according to strict purity standards and loaded onto the support materials. Deposition of the chemicals onto the support follows a protocol developed specifically for each tube type. The loaded support material is then dried as needed for the reaction.
- D. Tube Filling and Sealing.** End plugs are selected of materials that do not react with the reagent. The tubes are filled under conditions that minimize exposure to air, water vapor, or other gases that may affect the quality of the tubes. The tubes are then packed tightly by a combination of shaking and physical compression. The ends of the tubes are then melted closed using an automated flame sealer. Any necessary inert atmosphere is maintained through the tube-sealing process.
- E. Calibration.** Each batch of tubes is calibrated independently of other batches. A series of standard gases are purchased or prepared by a variety of methods, including flow dilution of gas primary standards, permeation tubes, and diffusion tubes, or static dilution from liquid or gas primary standards. Multiple tubes are used to determine each calibration position, and these are then printed onto each tube in the batch with an automated printing machine.

- F. Packaging.** The tubes and their technical data sheets are packed into labeled boxes with protective corrugated cardboard.
- G. Quality Control Sampling Plan.** A portion of each batch is sent to the Honeywell's Quality Assurance Laboratory for independent QA testing. The most widely used tubes pass the accuracy criterion of  $\leq \pm 15\%$  of length of stain. A separate set of tubes is stored in the QA laboratory and the manufacturing facility for evaluation at later dates, if necessary.
- H. Accuracy and Precision.** The accuracy is measured by testing at least five tubes and calculating the average deviation from the standard gas value. The precision is calculated as the standard deviation from the average value of the five measurements. All tubes meet the accuracy and precision criteria listed in Table 2-1:

Table 2-1. Honeywell Tube Accuracy and Precision Specifications

Tube Type	Conc. Range	Precision	Accuracy	
			>20-100% Full Scale	$\leq 20\%$ Full Scale
CO, CO <sub>2</sub> , H <sub>2</sub> O, H <sub>2</sub> S, NH <sub>3</sub> , PH <sub>3</sub> , SO <sub>2</sub>	>50 ppm	10%	10%	12%
CO, H <sub>2</sub> O, H <sub>2</sub> S, NH <sub>3</sub> , PH <sub>3</sub> , SO <sub>2</sub>	<50 ppm	12%	15%	20%
CO, Acetone, Benzene, MEK, Toluene, Xylene	All	12%	15%	20%
Cl <sub>2</sub> , ClO <sub>2</sub> , HCN, HCl, HF, NO <sub>x</sub> , NO <sub>2</sub> , RSH, RNH <sub>2</sub> , Butane, Diesel, Ethanol, Formaldehyde, Gasoline, Methyl Bromide, Ozone, Phenol, Trichloroethylene, Vinyl Chloride, others	All	20%	20%	25%

- I. Interim Storage.** Only batches that pass all quality assurance procedures are sent to interim storage, where they are maintained at 3-7°C (37 - 45°F) in darkness until shipment.



### 3. OPERATION OF DETECTION TUBES & PUMPS

#### CAUTION:



**Wear safety glasses and gloves when opening tubes or handling open tubes with sharp edges. Failure to wear protective equipment may lead to cuts and other severe injuries to eyes and hands.**



**Always test the pump for leaks immediately before using it for a series of measurements. Failure to test the pump for leakage may lead to dangerously inaccurate readings.**



**Avoid contact with tube contents in case of accidental breakage. Exposure to tube contents can result in significant health hazards.**



**Dispose of spent tubes according to local regulations. Review the reaction principle and other information listed in the Gas Detection Tube Data Sheet supplied to identify materials that may require special disposal procedures. (Data Sheets for all currently available Honeywell tubes are included in Chapter 5.)**

## 3.1 Hand Pump Description

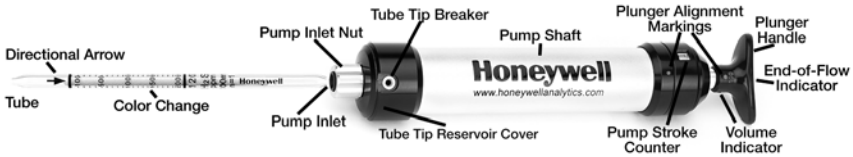

Figure 3-1. LP-1200 Hand Pump with tube inserted.

The LP-1200 is a piston-type hand pump that draws a fixed volume of gas, selectable at either 50 mL or 100 mL by rotating the handle. A tight vacuum seal is formed by a greased plunger gasket. The tapered rubber inlet accommodates a range of tube diameters for different types of tubes. The inlet filter prevents glass pieces and dust from entering the shaft. An end-of-flow indicator in the handle turns white when the gas sampling is complete. A pump stroke counter is rotated to keep track of the number of strokes completed.

## 3.2 Tube Measurements

### 3.2.1 Tube Description & Packaging

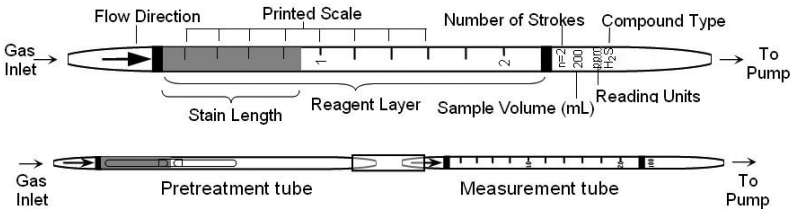

Figure 3-2. Gas detection tube parts description.  
Top: Standard single tube. Bottom: Pretreatment tube connected to measurement tube with rubber connector.

- 1. Tube and Box.** Figure 3-2 shows the key components of a Honeywell gas detection tube. The tubes are typically packaged in a box of 10 tubes. Each box has quick instructions on the back. Some tubes require preconditioning of the gas and are packaged with 5 pretreatment tubes and 5 measurement tubes for a total of 5 measurements. The concentration scale is printed on the tube and an arrow indicates the direction in which the gas must enter. The standard number of 100 mL

strokes is indicated on one side, along with the total sample volume, the unit of measure, the gas type, and the batch number.

- Data Sheet.** Each box is packaged with a Data Sheet that provides detailed information on the tube performance. Figure 3-3 is an excerpt of a typical data sheet. Complete data sheets are provided in Chapter 5 and discussed in detail in Chapters 4.2 and 4.3.

## Gas Detection Tube Data Sheet

### Hydrogen Sulfide $H_2S$ No. H-10-103-18

	Extended Range	Standard Range	Extended Range
Range (ppmv)	12.5 - 125	25 - 250	50 - 500
No. of Pump Strokes	2	1	0.5
Sample Volume (mL)	200	100	50
Sample Time (min)	2 x 1	1	1
Correction Factor (CF)	0.5	1	2

**Figure 3-3. Excerpt of a Tube Data Sheet**

- Part Number.** The 7-digit part number is indicated on the top right of the data sheet. The second 3 digits indicate the tube chemical type, and the last two digits number indicate the approximate range of the tube. The higher the number, the higher the range.
- Sampling Volume and Time.** Using the standard number of pump strokes, the concentration of the gas is read from stain length directly matched to the printed scale after the listed sampling time has elapsed. However, the range of the tube may be extended by using a smaller or larger sample volume. In such cases, the scale reading must be multiplied by a Correction Factor (CF) to adjust for the different sample size. For example, the Honeywell H-10-103-18 hydrogen sulfide tube has a standard range of 25-250 ppm. When used with the standard one stroke, the readings will correspond directly to the printed scale on the tube. When used with half a stroke, a Correction Factor (CF) of 2 is applied. An observed reading of 50 ppm then corresponds to an actual concentration of:

$$50 \times 2 = 100 \text{ ppm}$$

**5. Cross-sensitivity.** Gas detection tubes are generally quite selective, but some compounds may interfere in the measurements. The Data Sheet lists possible interfering compounds; others may also exist. In most cases these compounds increase the stain length, but in some cases they decrease the stain length. The user must be aware of potential interferences, or incorrect readings may result.

### 3.2.2 Testing Hand Pump For Leaks

Before a series of measurements, the pump used must be tested for leaks. Follow this procedure:

1. Insert an unopened tube snugly into the inlet of the aspirating pump.
2. Align the red dot on the plunger with the red dot on the pump shaft.
3. Pull the plunger one full stroke and wait 2 minutes.
4. Rotate the plunger dot away from the pump shaft alignment mark, and allow the plunger to be drawn back into the pump shaft. Keep your hand on the shaft to keep it from snapping back too suddenly.

There are no leaks if the plunger returns to within 3 mm of its original position. If a leak is detected, refer to Section 3.3 for maintenance procedures.

### 3.2.3 Measurement Procedure

1. Break both ends of a new detection tube using the tip breaker on the side of the pump. Insert the tube until it stops, and then back off about 1 mm before breaking off the tip. The latter procedure allows the tip to fall into the tip reservoir at the end of the pump shaft. The reservoir can be emptied by opening the rubber cover on the opposite side of the pump.

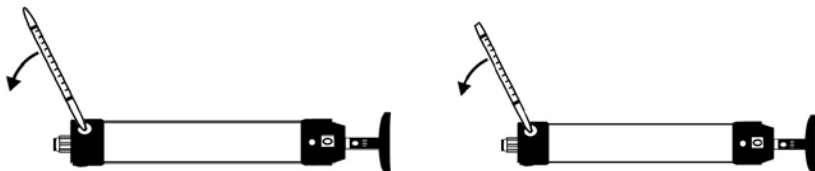

*Break tube open at both ends.*

2. In cases where a pre-tube is provided (e.g., Benzene H-10-101-01 and NOx H-10-109-20), connect the pre-tube to the measurement tube using the rubber connector in the direction indicated on the tube.

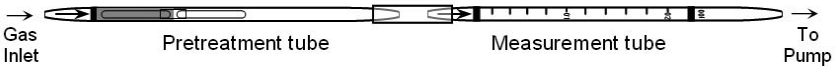

3. Insert the measurement tube securely into the rubber pump inlet. Point the tube arrow towards the pump (see Figs. 3-1 and 3-2).



*Insert open tube with arrow pointing towards pump.*

4. Select the sample volume desired and align the red dot on the plunger with the red dot on the pump shaft. Pull the handle quickly until it latches at ½ or 1 full stroke (50 or 100 mL) and wait for the sampling time indicated on the data sheet to allow the air to be drawn through the tube. The end-of-flow indicator is dark during sampling. Flow is complete when the end-of-flow indicator returns to its white color.

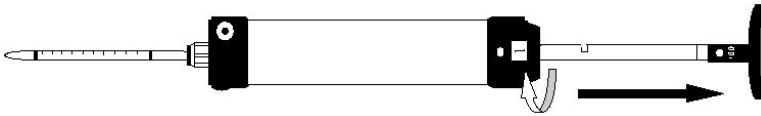

*Withdraw plunger sharply until it locks in place, and rotate stroke counter.*

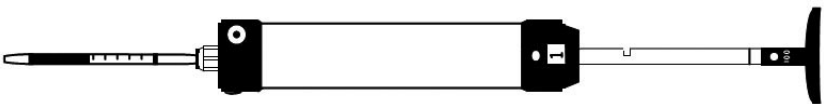

*Wait for indicated sampling time when end-of-flow indicator turns white.*



*End-of-flow indicator is dark when sampling (left) and white when sampling is complete (right).*

5. For additional pump strokes, rotate the handle  $\frac{1}{4}$  turn clockwise or counterclockwise and push it back fully without removing the tube from the pump. Then repeat Step 4.

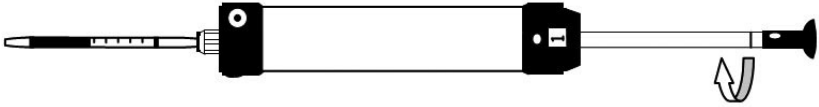

*If additional strokes are needed, rotate plunger 90 degrees.*

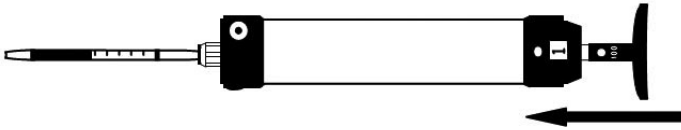

*Push plunger back into pump shaft without removing tube.*

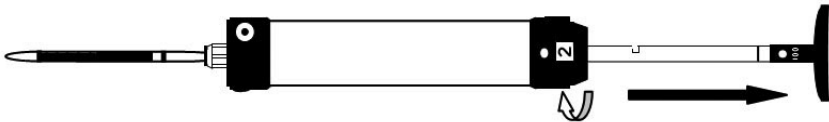

*Withdraw plunger for second stroke and repeat strokes as necessary.*

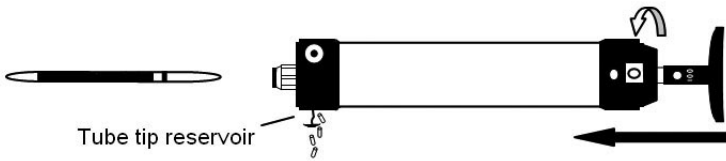

*Remove and read tube; return plunger and stroke counter to original position; empty tube tip reservoir as necessary.*

### 3.2.4 Reading Tubes

1. The concentration of the compound being measured is read directly from the scale printed on the tube.
2. The reading is taken as the furthest distance along the tube that the color change just becomes visible. If the leading edge is diagonal instead of perpendicular to the axis of the tube, use the average of the minimum and maximum values. The three tubes shown in Figure 3-4 are all read as 0.9.

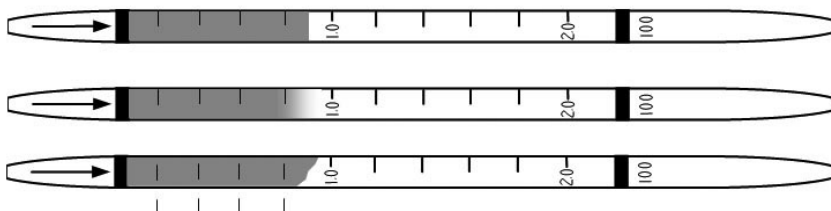

**Figure 3-4. Reading of various types of endpoints after sampling.**

3. Read the tube immediately after gas sampling, as colors may change, fade, or disperse with time.
4. If a non-standard number of pump strokes was used for sampling, multiply the reading by the Correction Factor given on the tube Data Sheet (Chapter 5).
5. If humidity and temperature corrections are necessary as indicated on the Data Sheets, multiply the observed readings by the given Correction Factor(s) (CF) to obtain the true concentration. For more details and a theoretical discussion, see Chapter 4.3 on the effects of humidity and temperature.
6. The user must be aware of potential interfering compounds in the tube measurements. Interferences can be either positive or negative.



**CAUTION: Always examine the data sheet and other available information for possible interferences. Failure to consider interferences may lead to dangerously inaccurate readings.**

### 3.3 Maintenance of the LP-1200 Piston Hand Pump

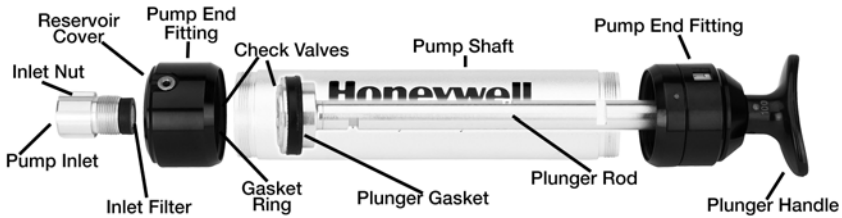

**Figure 3-5. Transparent view of LP-1200 pump showing internal parts.**

#### 1. Tube Tip Reservoir

Remove the tube tip reservoir cover as needed to empty the broken glass reservoir that is in the pump end fitting.

#### 2. Pump Inlet and Filter

The rubber pump inlet can become worn with use and result in leaks. Unscrew the pump inlet nut and replace the rubber inlet. If the inlet is not replaced, inspect the inlet filter and replace or clean the filter when it becomes visibly dirty or if the end-of-flow indicator on the pump shows that the flow takes longer than recommended on the tube box.

#### 3. Pump Mechanism

The plunger gasket may leak if it is worn or not well lubricated. To replace the gasket:

1. Unscrew the pump end fitting on the handle side.
2. Pull the plunger out of the pump shaft.
3. Replace the gasket.
4. Carefully push the plunger back into the shaft. Use a fine screwdriver or tweezers to help ease the gasket into the shaft.
5. Lubricate the inside of the shaft with vacuum grease to ensure a good seal.



**Caution: Do not overtighten the plunger gasket. It could cause a sudden loss of vacuum.**

The inlet check valve may cause leaks if worn or not lubricated. Unscrew the end fitting on the inlet side and pull out the disk-shaped rubber-inlet check valve. Replace as necessary, adding a light coat of grease around the hole.



Replace the outlet check valve gasket if there is resistance on the return stroke. Using the special tool or needle-nose pliers, unscrew the plunger tip from the plunger rod. Replace the O-ring, check valve gasket as necessary, and reassemble. Inspect the gasket ring in the inlet end fitting. If it is damaged, replace before screwing the end fitting back on.

### 3.4 Selection Of Sampling Pump

Honeywell tubes are designed for operation with a Honeywell hand pump for drawing samples through Honeywell tubes. Pumps from different manufacturers may have different flow patterns or deliver different volumes, which can cause significant errors. For example, bellows hand pumps as supplied by MSA and Draeger have substantially different flow patterns.



**Caution: Use of a sampling pump other than a Honeywell hand pump may cause serious errors. Always test any pump for leaks before use.**

### 3.5 Operation And Maintenance Of Remote Sampler

The Detection Tube Remote Sampler is designed for use with Honeywell hand pumps for gas-detection tubes and adsorption tubes. The flexible Remote Sampler allows gases to be sampled through narrow apertures, down holes, or from other areas remotely located from the sampling pump. The sampler is available in two lengths, 15 feet (4.5 meters), p/n H-010-3009-015, and 35 feet (11 meters), p/n H-010-3009-035.

#### 1. Installation

Refer to Figure 3.7 for installation and part descriptions. Unscrew the pump adapter nut and remove the standard rubber tube adapter from the pump. Inspect the remote sampler to ensure that the porous metal filter is in place, and screw the pump adapter nut attached to the sampler into the pump. Store the standard nut and rubber adapter in a safe place for later use.

## 2. Operation

To ensure a good seal, insert the gas detection tube into the tube holder and twist the tube while pushing in. If the tube uses a pre-tube, insert the pre-tube into the pre-tube holder and push the pre-tube into the end of the standard tube holder. Secure the pre-tube holder using the rubber buckles. Lower the extension hose to the desired position.

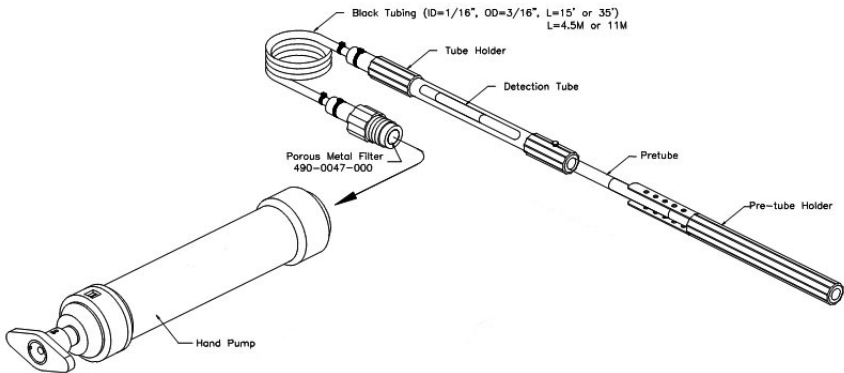

**Figure 3-6. Installation of the remote sampling probe into the LP-1200 hand pump.**

## 3. Correction

**Caution:** In order to obtain accurate readings, the following corrective procedures must be employed when using the 35-foot (11-meter) remote sampler.



The 35-foot (11-meter) remote sampler causes a slight delay and reduced reading because of the extra volume in the extension tubing. Increase the sample time by 30 seconds for a 2-minute tube, 20 seconds for a 1.5-minute tube, and by 15 seconds for a 1-minute tube. Then multiply the reading by 1.08 to obtain the corrected value. Corrections for the 15-foot (4.5-meter) remote sampler are unnecessary.

#### 4. Routine Maintenance

- a. Porous Metal Filter: The metal frit filter should be replaced when it becomes visibly dirty or if the end-of-flow indicator on the pump shows that the flow takes longer than recommended on the tube box.
- b. Leak Test: If a leak is discovered with either pump, first remove the probe and check the pump for leaks. Then examine the tubing and connections for the leak source, as follows:
  - i. Hand Pump: Insert a sealed tube into the tube holder tightly. Pull 3 pump strokes to expel the air from inside the tubing. Pull a fourth stroke and wait for 2 minutes. Rotate the plunger dot away from the pump shaft alignment mark, and allow for the plunger to be drawn back into the pump shaft. Keep your hand on the shaft to prevent it from springing back too suddenly. If the plunger returns to within 3 mm of its original position, there are no leaks.



## 4. TECHNICAL INFORMATION

### 4.1 Gas Detection Tube Theory Of Operation

Gas detection tubes operate on a chemical reaction between the vapor-phase compound and a liquid or solid detecting reagent, which is supported on an inert matrix. The most common types of reactions are the following:

- **Acid-base reactions** These include reactions of acidic gases like HCl and HF with bases, and reaction of alkaline vapors such as ammonia with an acid in the tube. A dye present in the tube changes color as the pH changes on exposure to the vapors.
- **Reduction-oxidation (Red-ox) reactions** These generate an oxidized or reduced compound, which has a different color. The chlorine tube uses oxidative coupling of colorless o-toluidine to form an orange azo-dye. White di-iodine pentoxide is reduced by CO and many organic vapors to form deep brown-colored iodine. Orange chromium (VI) is reduced by many organic compounds to form brown or green-colored Cr(III) compounds.
- **Ligand-exchange reactions** These generate new complexes that are more colored than the starting reagents. The most notable is the conversion of white lead acetate to brown-black lead sulfide in the detection of H<sub>2</sub>S. In the case of phosphine, the exchange of PH<sub>3</sub> for the chlorine ligand of HgCl<sub>2</sub> releases HCl, which then causes a pH-dependent dye-color change.
- **Pre-layers or Pre-tubes** These are used to condition the sample by controlling humidity, removing interferences, or transforming the analyte to another detectable compound. Examples include drying agents in NH<sub>3</sub> and HCl tubes, organic removal by charcoal or oxidation in selective CO tubes, and oxidation of NO to NO<sub>2</sub> in the nitrogen oxides tube.

All Honeywell detection tubes are length-of-stain types. In these tubes, the reaction of the gas with the supported reagent is fast, compared to the transport of the bulk air sample through the tube. Therefore, all of the detected vapors are reacted within the tube. As a result, there is not a strong dependence of the readings on the rate at which the gas is sampled. However, a very high flow rate can cause some smearing to a high reading. Conversely, low flow rates are less likely to affect the stain

length, but can give low readings by concentrating the colored products in a shorter section of the tube. In cases of flow extremes, errors outside the standard 25% accuracy can be produced.

Honeywell tubes are calibrated using Honeywell piston hand pumps. The flow during a single pump stroke initially rises sharply and then decays exponentially (see Figure 4-1). The best accuracy is therefore obtained when the flow through the tube mimics this profile.

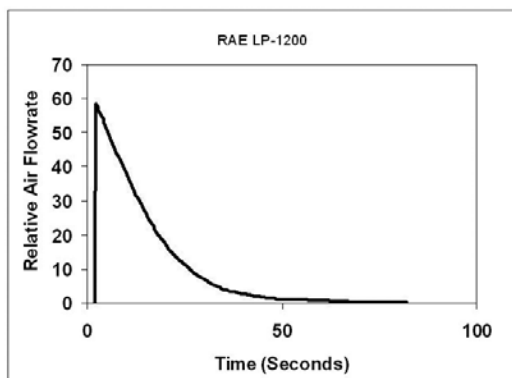

Figure 4-1. Piston pump internal pressure pattern. Data is offset by 2 seconds.

## 4.2 Explanation Of Data Sheets

The Data Sheets supplied with each box of tubes give representative information applying to all batches. The Data Sheets include:

1. **Standard and extended measurement ranges**, pump strokes required, gas volumes required, sampling times, and the detection limit. The standard range and strokes apply to the calibration scale printed on the tubes. The range can usually be extended to higher or lower concentrations by reducing or increasing, respectively, the number of pump strokes.
2. **Correction Factors (CF)** for conditions of pump stroke, temperature, humidity, or gas type other than the standard conditions. The CF is multiplied by the observed reading to obtain the corrected concentration.

- 3. Precision.** This value is determined by measuring a standard gas sample with at least 5 randomly chosen tubes. Precision is reported as the standard deviation from the average of the 5 measurements. Precision is typically  $\pm 15\%$ . (See Section 2 for complete table.)
- 4. Linearity** with number of pump strokes. Multiple strokes are measured with a gas standard with concentration at the low end of the tube. Tubes must have correlation coefficients ( $r^2$ )  $>0.95$  to be considered linear.
- 5. Humidity.** The effect on the reading as a function of humidity of the standard gas is listed. Any required Correction Factors are tabulated.
- 6. Temperature.** The effect of temperature is determined by equilibrating the gas sample, tube, and pump to the test temperatures, typically  $0^\circ$ ,  $10^\circ$ ,  $25^\circ$ , and  $40^\circ\text{C}$  ( $32^\circ$ ,  $50^\circ$ ,  $77^\circ$ , and  $104^\circ\text{F}$ ). Any required Correction Factors are tabulated. If humidity has a measurable effect on the gas readings, the temperature tests are performed at constant relative humidity (not absolute humidity). Any temperature corrections should be multiplied by any humidity corrections to obtain true readings.
- 7. Storage Life.** Samples of tubes are stored for extended periods to evaluate their accuracy at defined time periods to determine their storage life. The user should store tubes in darkness at  $3^\circ$  to  $7^\circ\text{C}$  ( $37^\circ$  to  $45^\circ\text{F}$ ) to maximize their shelf life. Freezing tubes (storage below  $0^\circ\text{C}$ , or  $32^\circ\text{F}$ ) can damage some types and is not recommended.
- 8. Cross-Sensitivity.** Tubes are challenged with a variety of possible interfering gases to quantitate their relative response. Although the tubes are highly selective, compounds that are chemically similar to a target compound sometimes show a positive interference. Others interfere with the measurement gas without showing a response on their own; for example, when acidic vapors coexist with basic vapors. Such information is listed in a separate note or column titled "Interferes in Mixtures." The user should know as much about the sample environment as possible in order to make sound judgments regarding possible interferences; otherwise inaccurate readings may result. In some cases, a different color or pattern of the stain can clue the user to the presence of an interfering compound.

## 4.3 Humidity, Temperature, Pressure, and Matrix Effects

### 1. Humidity

Humidity has little effect on most tubes either because the reaction is insensitive to moisture or because drying agents are added to absorb the moisture in a pre-layer (see Figure 4-2). Humidity tends to have the greatest effect on compounds that are highly water-soluble, such as acids and bases. HF (hydrofluoric acid) is a notable example that requires humidity corrections; water-adsorbing prelayers cannot be used because they tend to be reactive with HF. The humidity effect tends to be greater as the concentration range of the tube is lowered. When correcting for humidity, the CF is multiplied by the reading in addition to multiplying by any temperature correction. Any necessary Correction Factors are listed in the individual tube data sheets. Note that the relative humidity at the measurement temperature defines the correction, rather than the absolute humidity.

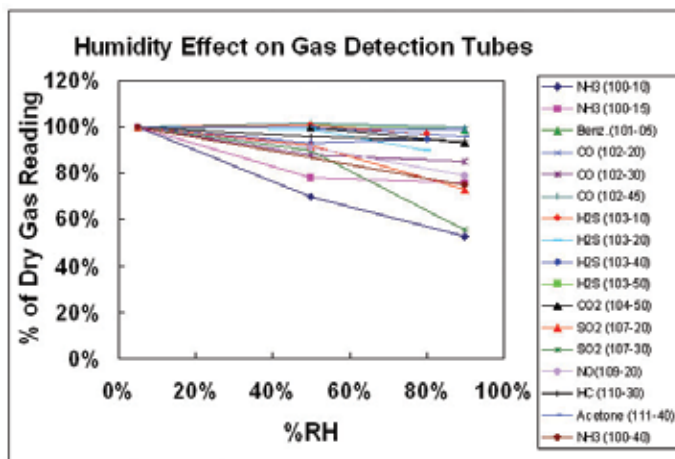

Figure 4-2. Effect of humidity on gas detection tube readings.



## 2. Temperature

Temperature can affect gas tube readings in at least three ways. First, as the temperature increases, the gas density decreases, causing a tendency for the reading to decrease (see pressure effects described in the next section). Second, as the temperature increases, the reaction rate increases, causing the reading to be sharper and shorter. A third, balancing effect is that adsorption is often a prerequisite for reaction. Adsorption is weaker as temperature increases, and thus the reading can become longer. The interplay of these competing effects results in some stains that are longer with increasing temperature, and others that are shorter.

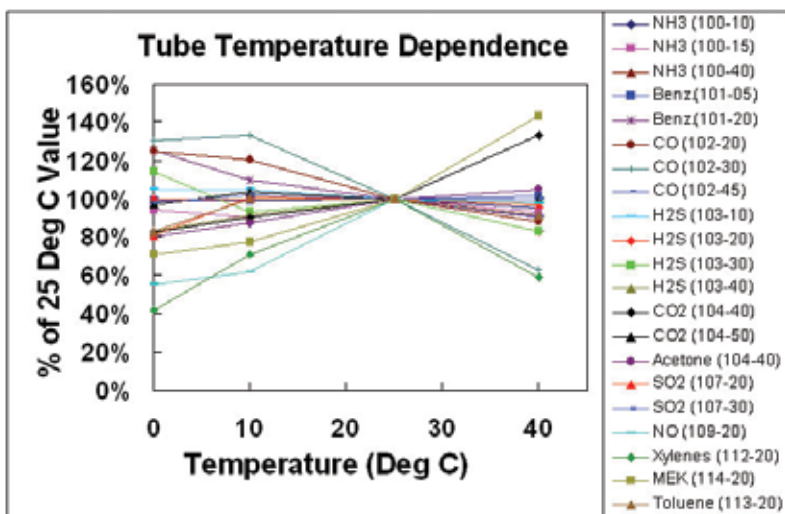

Figure 4-3. Effect of temperature on gas detection tube readings.

Additional factors occur in special cases. For example, pretube or prelayer reactions are sometimes more complete at higher temperatures, causing higher readings in the measurement layer. In some cases, the color of the stain can change. In the water vapor H-10-120-20 tube, the color stain is green at room temperature and a more purple color below room temperature.

### 3. Pressure

Tubes change color in proportion to the mass of the compounds reaching the reagent (i.e., the absolute concentration). Therefore, as the pressure decreases at higher altitudes, the apparent response is reduced because there are fewer molecules per unit volume sampled. The conventional desired reading is in ppmv (parts per million by volume), which is a relative concentration, such as a mole or volume fraction (% of molecules of compound per molecules of total gas [air]), rather than an absolute concentration.

All Honeywell tubes are calibrated at 1 atmosphere (760 mm Hg) pressure at sea level.

- For tubes calibrated in absolute concentrations such as lbs./MMCF or mg/m<sup>3</sup>, no pressure corrections are needed.
- For tubes calibrated in relative concentrations (e.g., ppm), correct for pressure using one of the following equations:

$$\text{Corrected reading} = \frac{\text{Observed Reading} \times 760 \text{ mm Hg}}{\text{Pressure (mm Hg)}}$$

$$\text{Corrected reading} = \frac{\text{Observed Reading} \times 101.3 \text{ kPa}}{\text{Pressure (kPa)}}$$

$$\text{Corrected reading} = \frac{\text{Observed Reading} \times 14.7 \text{ psia}}{\text{Pressure (psia)}}$$

The pressure in mm Hg can be estimated as a function of altitude using the following equation:

$$P \text{ (mm Hg)} = 760 \exp(-0.1286[\text{alt}(\text{km})]) \text{ below 2 km}$$

Example Correction Factors are listed in the following table as a function of altitude. Weather changes may also affect the atmospheric pressure, but the necessary corrections are usually <10%.

Example Location	Altitude (km)	Altitude (feet)	Pressure, (mm Hg)	CF
San Francisco, CA	0	0	760	1.00
Atlanta, GA	0.3	1000	731	1.04
Spokane, WA	0.6	2000	703	1.08
Rapid City, SD	0.9	3000	676	1.12
Salt Lake City, UT	1.2	4000	650	1.17
Denver, CO	1.5	5000	625	1.22
Colo. Spgs., CO	1.8	6000	601	1.27
Santa Fe, NM	2.1	7000	578	1.32
Alta, UT	2.4	8000	555	1.37
Winter Park, CO	2.7	9000	534	1.42
Keystone, CO	3.0	10000	514	1.48

#### 4. Matrix Gas

The matrix gas usually has little or no effect on the tube readings as long as the gas does not chemically react with the tube reagents or measured compound. Thus, readings in air, nitrogen, hydrogen, helium, or carbon dioxide give essentially the same results. However, the viscosity of the gas has a significant effect on the sampling time. Thus, for example, the sampling time of the CO H-10-102-18 tube is about half as long in pure hydrogen (viscosity 9.0  $\mu\text{Pa}\cdot\text{s}$ ) as it is in air (viscosity 18.6  $\mu\text{Pa}\cdot\text{s}$ ).

Matrix Gas	Viscosity @ 27°C ( $\mu\text{Pa}\cdot\text{s}$ )	Sampling Time Relative to Air	Sampling Time for a 90 second Tube (seconds)
Air	18.6	1.00	90
n-Butane	7.5	0.40	36
Propane	8.3	0.45	40
Hydrogen	9.0	0.48	44
Ethane	9.5	0.51	46
Acetylene	10.4	0.56	50
Methane	11.2	0.60	54
Carbon Dioxide	15.0	0.81	73
Nitrogen	17.9	0.96	87
Helium	20.0	1.08	97
Oxygen	20.8	1.12	101
Argon	22.9	1.23	111
Neon	32.1	1.73	155

At a given viscosity, higher flow rates tend to give longer stains. However, this is often compensated by higher diffusion rates to the reactive surface in the less viscous gases, resulting in no significant effect on the readings.

## 5. DATA SHEETS FOR GAS DETECTION TUBES

# Acetone C<sub>3</sub>H<sub>6</sub>O

# No. H-10-111-40

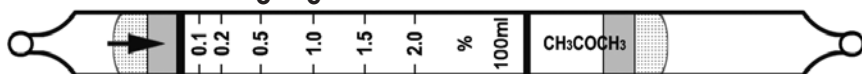

	Extended Range	Standard Range	Extended Range
Range (ppmv)	0.05 - 1%	0.1 - 2%	0.2 - 4%
No. of Pump Strokes	2	1	0.5
Sample Volume (mL)	200	100	50
Sample Time (min)	2 x 2	2	1.5
Correction Factor	0.5	1	2

Precision (Relative Standard Deviation)\*: ≤ ±12%

Linearity with No. of Pump Strokes: r<sup>2</sup> = 0.992

Humidity: No effect 5 - 85% RH

Temperature Range: 0 - 40°C (32 - 104°F)

Temp (°C/°F)	0/32	10/50	25/77	40/104
Corr. Factor	1.25	1.15	1.0	0.95

Storage Life: 2 years in darkness at 5 - 25°C (40 - 77°F). Refrigeration preferred.

Color Change: Orange → Black

Reaction Principle: CH<sub>3</sub>COCH<sub>3</sub> + Cr(VI) + H<sub>2</sub>SO<sub>4</sub> → Cr(III) + Oxidation Prods.

<u>Cross-sensitivity:</u> Substance	Concentration (ppmv)	Apparent Reading*	Corr. Factor
Methyl ethyl ketone	0.6%	0.55%	1.1
Methyl propyl ketone	1.0%	0.65%	1.5
Methyl isobutyl ketone	1.0%	0.40%	2.5
CO	1.5%	0	-
CO <sub>2</sub>	1.5%	0	-
CH <sub>4</sub>	2.5%	0	-
NH <sub>3</sub>	5.0%	1.4% brown	3.6
H <sub>2</sub> S	300	0.5% diffuse#	-
Ethyl Acetate	1.0%	0.85% diffuse#	-
Hexane	0.24%	entire tube#	-
Isobutylene	0.20%	entire tube#	-
Toluene	400	0.3% diffuse#	-

\* Data based on Honeywell pumps and tubes used in standard range.

# Faint black color over entire stain length. Ketones can be distinguished by their darker stains and sharp endpoints.

Other Possible Interferences: Other hydrocarbons.

# Amines $\text{RNH}_2$ ( $\text{CH}_3\text{NH}_2$ ) No. H-10-132-10

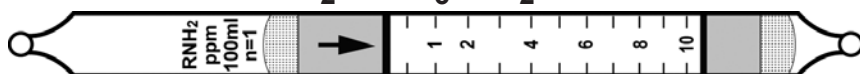

	Extended Range	Standard Range	Extended Range
Range (ppmv)	0.25 - 5	0.5 - 10	1.0 - 20
No. of Pump Strokes	2	1	0.5
Sample Volume (mL)	200	100	50
Sample Time (min)	2 x 1	1	1
Correction Factor	0.5	1.0	2.0

**Precision (Relative Standard Deviation)\*:**  $\leq \pm 20\%$

**Linearity with No. of Pump Strokes:**  $r^2 = 0.997$

**Humidity:** No effect 0 - 90% RH

**Temperature Range:** 0 - 40°C (32 - 104°F) @ constant 50%RH.

Temp (°C/°F)	0/32	10/50	20/68	30/86	40/104
Corr. Factor	1.16	1.10	1.0	0.96	0.96

**Storage Life:** 1 year in darkness at 5-25°C (40-77°F). Refrigeration preferred.

**Color Change:** Pink → Yellow

**Reaction Principle:**  $2\text{RNH}_2 + \text{H}_2\text{SO}_4 \rightarrow (\text{RNH}_3)_2\text{SO}_4$

Cross-sensitivity: Substance	Concentration (ppmv)	Apparent Reading*	Correction Factor
Ammonia	5	6.0	0.8
Methylamine	10	10*	1.0
Ethylamine	8	7.0	1.1
Allylamine	7.4	8.0	0.93
Diethylamine	5	6.3	0.79
Trimethylamine	4.5	9.8	0.46
Triethylamine	6	9.5	0.63
Methylaziridine (Propylene imine)	5	6.5	0.77
Ethylenediamine	7	2.0 <sup>#</sup>	3.5
Ethanolamine	36	4.1 <sup>#</sup>	8.8
Pyridine	10	Over range <sup>†</sup>	-
H <sub>2</sub> S	100	0	
CO	500	0	
Isobutylene	100	0	
HCl	1000	0 <sup>£</sup>	

\* Data based on Honeywell pump and tubes used in standard range. This tube is calibrated using methylamine.

<sup>#</sup> Deep purple with yellow stain at endpoint.

<sup>†</sup> Slight color change to light pink.

<sup>£</sup> Interferes in mixtures.

**Other Possible Interferences:** Other bases.

# Ammonia NH<sub>3</sub>

No. H-10-100-05

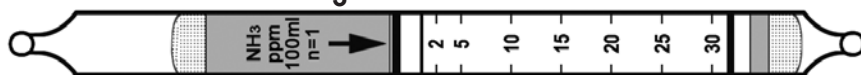

	Extended Range	Standard Range	Extended Range
Range (ppmv)	0.5 - 15	1 - 30	2 - 60
No. of Pump Strokes	2	1	0.5
Sample Volume (mL)	200	100	50
Sample Time (min)	2 x 1.5	1.5	1
Correction Factor	0.55	1	2.4

Precision (Relative Standard Deviation)\*:  $\leq \pm 12\%$

Linearity with No. of Pump Strokes:  $r^2 = 0.999$

Humidity: The tubes are calibrated at 50% RH @ 24 °C (75 °F)

% RH	< 5%	10%	50%	80%	95%
Corr. Factor	0.8	0.85	1.0	1.0	1.0

Temperature Range: 0 - 40°C (32 - 104°F) @ constant 50%RH

Temp (°C/°F)	0/32	10/50	25/77	35/95
Corr. Factor	0.9	0.95	1.0	1.1

Storage Life: 2 years in darkness at 5 - 25°C (40-77°F). Refrigeration preferred.

Color Change: Purple → Beige

Reaction Principle: Prelayer reduces humidity effects



Cross-sensitivity: Substance	Concentration (ppmv)	Apparent Reading*
Pyridine	10	15
Diethylamine	20	18
Hydrazine	20	2**
Methylhydrazine	20	2.3**
CO	100	0
CO <sub>2</sub>	20000	0#
H <sub>2</sub> S	200	0
Hexane	100	0
Isobutylene	100	0
Toluene	100	0

\* Data based on Honeywell pumps and tubes used in standard range.

\*\* These hydrazines can be measured using 2 strokes with a CF of 5.

# 16000 ppm CO<sub>2</sub> reduces the NH<sub>3</sub> response by 30% in mixtures, 5000 ppm CO<sub>2</sub> reduces

NH<sub>3</sub> response by 10% in mixtures, and 1000 ppm CO<sub>2</sub> has no effect.

Other Possible Interferences: Amines and other bases.

# Ammonia NH<sub>3</sub>

No. H-10-100-10

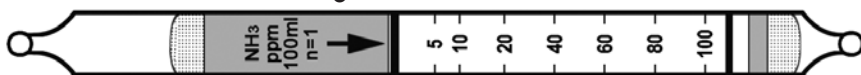

	Extended Range	Standard Range	Extended Range
Range (ppmv)	2.5 - 50	5 - 100	10 - 200
No. of Pump Strokes	2	1	0.5
Sample Volume (mL)	200	100	50
Sample Time (min)	2 x 1	1	1
Correction Factor	0.5	1	2

Precision (Relative Standard Deviation)\*:  $\pm 12\%$

Linearity with No. of Pump Strokes:  $r^2 = 1.000$

Humidity: @ 24 °C (75 °F) The tubes are calibrated at 50% RH.

% RH	< 5%	20%	50%	70%	90%
Corr. Factor	0.7	0.8	1.0	1.1	1.3

Temperature Range: 0 - 35°C (32 - 95°F) @ constant 50% RH

Temp (°C/°F)	0/32	10/50	24/75	34/93
Corr. Factor	0.8	1.0	1.0	1.0

Storage Life: 2 years in darkness at 3 - 10°C (37 - 50°F). Refrigeration required.

Color Change: Purple → Beige

Reaction Principle: Prelayer reduces humidity effects



Cross-sensitivity: Substance	Concentration (ppmv)	Apparent Reading*
Butylamine	100#	45
Diethylamine	50#	60
CO	250	0
H <sub>2</sub> S	100#	0
SO <sub>2</sub>	100#	0
CH <sub>4</sub>	50000	0
CO <sub>2</sub>	50000	0
NO <sub>2</sub>	200	0
Hexane	100	0
Isobutylene	100	0
Toluene	100	0

\* Data based on Honeywell pumps and tubes used in standard range. # At 50% RH.

Other Possible Interferences: Amines and other bases.

# Ammonia NH<sub>3</sub>

No. H-10-100-12



	Extended Range	Standard Range	Extended Range
Range (ppmv)	5 - 130	10-260	20 - 520
No. of Pump Strokes	2	1	0.5
Sample Volume (mL)	200	100	50
Sample Time (min)	2 x 1.5	1.5	1
Correction Factor	0.5	1	2

Precision (Relative Standard Deviation)\*: ≤ ± 12%

Linearity with No. of Pump Strokes: r<sup>2</sup> = 1.000

Humidity: @ 22 °C (72 °F) The tubes are calibrated at 50% RH.

% RH	< 5%	10%	50%	70%	90%
Corr. Factor	0.8	0.9	1.0	1.0	1.0

Temperature Range: 0 - 40°C (32 - 104°F) @ constant 50%RH

Temp (°C/°F)	0/32	10/50	22/72	40/104
Corr. Factor	0.8	1.0	1.0	1.0

Storage Life: 2 years in darkness at 3 - 10°C (37 - 50°F). Refrigeration required.

Color Change: Purple → Beige

Reaction Principle: Prelayer reduces humidity effects



Cross-sensitivity: Substance	Concentration (ppmv)	Apparent Reading*
Butylamine	200#	200
Diethylamine	200#	260
CO	250	0
H <sub>2</sub> S	100#	0
SO <sub>2</sub>	100#	0
CH <sub>4</sub>	50000	0
CO <sub>2</sub>	50000	0
NO <sub>2</sub>	200	0
Hexane	100	0
Isobutylene	100	0
Toluene	100	0

\* Data based on Honeywell pumps and tubes used in standard range.

# At 50% RH.

Other Possible Interferences: Amines and other bases.



# Ammonia NH<sub>3</sub>

No. H-10-100-15

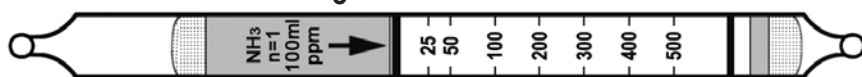

	Extended Range	Standard Range	Extended Range
Range (ppmv)	12 - 250	25 - 500	50 - 1000
No. of Pump Strokes	2	1	0.5
Sample Volume (mL)	200	100	50
Sample Time (min)	2 x 1	1	1
Correction Factor	0.56	1	2

Precision (Relative Standard Deviation)\*:  $\leq \pm 12\%$

Linearity with No. of Pump Strokes:  $r^2 = 0.998$

Humidity: No effect at 10 - 90% RH. At <5% RH multiply the reading by 0.8.

Temperature Range: 0 - 40°C (32 - 104°F) @ constant 50%RH.

Temp (°C/°F)	0/32	10/50	24/75	40/104
Corr. Factor	1.3	1.0	1.0	1.2

Storage Life: 2 years in darkness at 3 - 10°C (37 - 50°F). Refrigeration required.

Color Change: Purple → Beige

Reaction Principle: Prelayer reduces humidity effects



<u>Cross-sensitivity:</u> Substance	Concentration (ppmv)	Apparent Reading*
Butylamine	300 <sup>#</sup>	200
Diethylamine	100 <sup>#</sup>	90
CO	250	0
CO <sub>2</sub>	50000	0
H <sub>2</sub> S	250	0
SO <sub>2</sub>	500 <sup>#</sup>	0 <sup>†</sup>
NO <sub>2</sub>	200	0
CH <sub>4</sub>	25000	0
Hexane	1500	0
Toluene	200	0
Isobutylene	5000	0

\* Data based on Honeywell pumps and tubes used in standard range.

<sup>#</sup>At 50% RH. <sup>†</sup>Reduces reading in mixtures

Other Possible Interferences: Amines and other bases.

# Ammonia NH<sub>3</sub>

No. H-10-100-40



	Extended Range	Standard Range	Extended Range
Range (ppmv)	0.5 - 7.5%	1 - 15%	2 - 30%
No. of Pump Strokes	2	1	0.5
Sample Volume (mL)	200	100	50
Sample Time (min)	2 x 2	2	1.5
Correction Factor	0.5	1	2

Precision (Relative Standard Deviation)\*: ≤ ± 10%

Linearity with No. of Pump Strokes: r<sup>2</sup> = 0.999

Humidity: 85% RH reduces the reading by about 25% compared to dry air

Temperature Range: No effect 0 - 40°C (32 - 104°F)

Storage Life: 2 years in darkness at 5 - 25°C (40 - 77°F). Refrigeration preferred.

Color Change: Orange → Deep Purple

Reaction Principle:  $3\text{NH}_3 + \text{H}_3\text{PO}_4 \rightarrow (\text{NH}_4)_3\text{PO}_4$

<u>Cross-sensitivity:</u> Substance	Concentration (ppmv)	Apparent Reading*
CO	3000	0
CO <sub>2</sub>	100000	0
SO <sub>2</sub>	200	0
NO	100	0
Hexane	100	0
Isobutylene	1000	0
CH <sub>4</sub>	25000	0

\* Data based on Honeywell pumps and tubes used in standard range.

Other Possible Interferences: Amines and other bases

# Benzene Specific C<sub>6</sub>H<sub>6</sub> No. H-10-101-01

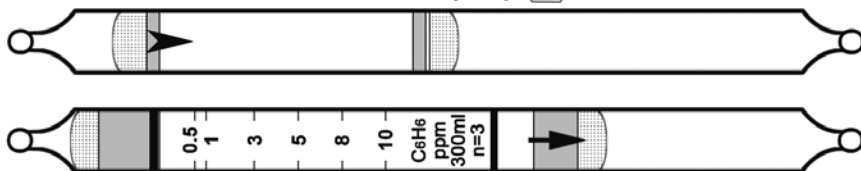

	Extended Range	Standard Range	Extended Range
Range (ppmv)	0.25 - 5	0.5-10	1.5 - 30
No. of Pump Strokes	6	3	1
Sample Volume (mL)	600	300	100
Sample Time (min)	6 x 3	3 x 3	3
Correction Factor	0.27	1	4

**Precision (Relative Standard Deviation)\*:** ≤±12%

**Humidity:** No effect 0 - 95% RH

**Temperature Range:** 0 - 40°C (32 - 104°F)

Temp (°C/°F)	0/32	10/50	25/77	40/104
Corr. Factor	2.7	1.6	1.0	0.6

**Storage Life:** 1 year in darkness at 5 - 25°C (40 - 77°F). Refrigeration preferred.

**Color Change:** White → Brown

**Reaction Principle:** Pretube removes interferences

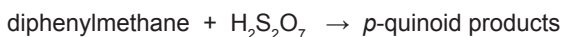

<b>Cross-sensitivity:</b> Substance	Concentration (ppmv)	Apparent Reading*
Isobutylene	100	0
n-Hexane	500#	0
n-Heptane	100	0
Toluene	100	0
m-Xylene	50	0
m-Xylene	100	5
CH <sub>4</sub>	25000	0
CO	10	0
H <sub>2</sub> S	25	0

\* Data based on Honeywell pumps and tubes used in standard range.

# Hexane above 100 ppm will reduce the benzene response.

**Other Possible Interferences:** Hydrocarbons and similar reducing gases.

# Benzene Specific C<sub>6</sub>H<sub>6</sub> No. H-10-101-10

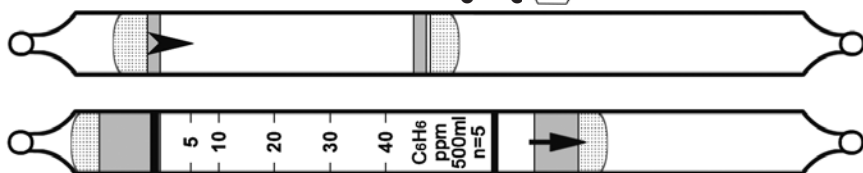

	Extended Range	Standard Range	Extended Range
Range (ppmv)	2.5 - 20	5 - 40	25 - 200
No. of Pump Strokes	10	5	1
Sample Volume (mL)	1000	500	100
Sample Time (min)	10 x 3	5 x 3	3
Correction Factor	0.5	1	5

Precision (Relative Standard Deviation)\*: ≤ ± 12%

Humidity: No effect 5 - 100% RH

Temperature Range: No effect 0 - 40°C (32 - 104°F)

Storage Life: 1 year in darkness at 5 - 25°C (40 - 77°F). Refrigeration preferred.

Color Change: White → Light Brown

Reaction Principle: Pretube removes interferences



<u>Cross-sensitivity:</u> Substance	Concentration (ppmv)	Apparent Reading*
Isobutylene	100	~2 (faint)
n-Hexane	10	0
n-Octane	100	0
Toluene	35	0 <sup>#</sup>
m-Xylene	50	0 <sup>#</sup>
β-Pinene	50	~2 (very faint)
CO	10	7
H <sub>2</sub> S	25	0

\* Data based on Honeywell pumps and tubes used in standard range.

<sup>#</sup>With 10 strokes, toluene and xylene at 50 ppm read 2 ppm and 100 ppm octane reads ≤2 ppm.

Other Data: Without the pretube the readings are 30% higher.

# Benzene C<sub>6</sub>H<sub>6</sub> No. H-10-101-20

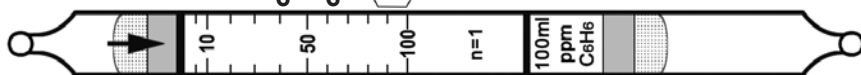

	Extended Range	Standard Range	Extended Range
Range (ppmv)	2.5 - 50	5 - 100	10 - 200
No. of Pump Strokes	2	1	0.5
Sample Volume (mL)	200	100	50
Sample Time (min)	2 x 2	2	1.5
Correction Factor	0.5	1	2

Precision (Relative Standard Deviation)\*:  $\leq \pm 12\%$

Linearity with No. of Pump Strokes:  $r^2 = 0.992$

Humidity: No effect 5 - 95% RH

Temperature Range: 0 - 40°C (32 - 104°F)

Temp (°C/°F)	0/32	10/50	21/70	40/104
Corr. Factor	0.8	0.9	1.0	1.1

Storage Life: 2 years in darkness at 5 - 25°C (40 - 77°F). Refrigeration preferred.

Color Change: White → Light Brown

Reaction Principle: C<sub>6</sub>H<sub>6</sub> + I<sub>2</sub>O<sub>5</sub> + H<sub>2</sub>S<sub>2</sub>O<sub>7</sub> → I<sub>2</sub> + oxidation products

<u>Cross-sensitivity:</u> Substance	Concentration (ppmv)	Apparent Reading*
CO	50	40
CO <sub>2</sub>	50000	0
H <sub>2</sub> S	50	20
NO	100	40
NH <sub>3</sub>	100	0
CH <sub>4</sub>	25000	0
SO <sub>2</sub>	10	0
Hexane	50	>100
Isobutylene	100	10
Toluene	100	20
o-Xylene	50	3

\* Data based on Honeywell pumps and tubes used in standard range.

Other Possible Interferences: Hydrocarbons and similar reducing gases.

# 1,3-Butadiene CH<sub>2</sub>=CHCH=CH<sub>2</sub> No. H-10-135-04

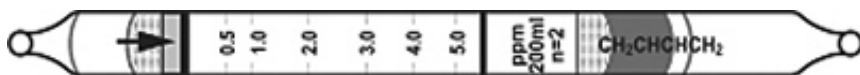

	Extended Range	Standard Range	Extended Range
Range (ppmv)	0.25-2.5	0.5-5	1-10
No. of Pump Strokes	4	2	1
Sample Volume (mL)	400	200	100
Sample Time (min)	4 x 2	2 x 2	2
Correction Factor	0.43	1	2.4

Precision (Relative Standard Deviation)\*:  $\leq \pm 15\%$

Linearity with No. of Pump Strokes:  $r^2 > 0.998$

Humidity Range: no effect 0 - 90% RH.

Temperature Range: 0 - 40°C (32 - 104°F)

Temp (°C/°F)	0/32	10/50	20/68	30/86	40/104
Corr. Factor	1.5	1.15	1.0	0.85	0.8

Storage Life: 2 years in darkness below 10°C (50°F). Refrigeration required.

Color Change: Pink → White

Reaction Principle: CH<sub>2</sub>=CHCH=CH<sub>2</sub> + KMnO<sub>2</sub> → Oxidation products

Cross-sensitivity: Substance	Concentration (ppmv)	Apparent Reading*
Isobutylene	5	4.4
Ethylene	10	0**
Hexane	100	0
Toluene	100	0
CH <sub>4</sub>	75000	0
CO <sub>2</sub>	4000	0
CO	400	0
H <sub>2</sub> S	30	0
SO <sub>2</sub>	5	0.5
NO	8	1.9
NO <sub>2</sub>	10	0.5
NH <sub>3</sub>	50	0
HCN	10	0

\*Data based on Honeywell and tubes used in standard range.

\*\* The entire tube changes to very light pink, no boundary.

**Caution:** Dispose of spent or expired tubes according to local regulations.

Possibly hazardous materials are given under the section Reaction Principle.

# n-Butane



No. H-10-137-30

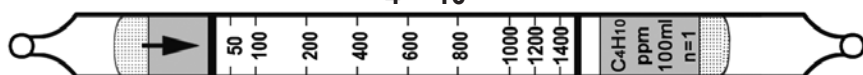

	Extended Range	Standard Range	Extended Range
Range (ppmv)	12.5– 700	25 - 1400	50 - 2800
No. of Pump Strokes	2	1	0.5
Sample Volume (mL)	200	100	50
Sample Time (min)	2 x 2.5	2.5	2
Correction Factor	0.5	1	2

Precision (Relative Standard Deviation)\*:  $\leq \pm 20\%$

Linearity with No. of Pump Strokes:  $r^2 > 0.999$

Humidity: No effect 5 - 100% RH.

Temperature Range: No effect 0 - 40°C (32 - 104°F).

Storage Life: 2 years in darkness at 5 - 25°C (40 - 77°F). Refrigeration preferred.

Color Change: Yellow-Orange → Brown (greenish)

Reaction Principle:  $C_4H_{10} + K_2Cr_2O_7 + H_2SO_4 \rightarrow Cr(III) + \text{Oxidation Products}$

Cross-sensitivity: Substance	Concentration (ppmv)	Apparent Reading*	Correction Factor
CH <sub>4</sub>	25000	0	-
Propane	500	~650 (l.brown)#	~0.8
Isobutane	100	20	~5
Isobutylene	1500	~15	~100
n-Pentane	200	80 (green)#	2.5
n-Hexane	1500	530 (green)#	2.8
CO	500	0	-
H <sub>2</sub> S	500	90	5.6
Ethanol	1000	~3	>300
Acetone	1000	~9	>100
Methyl Ethyl Ketone	1000	~8	>100

\* Data based on Honeywell pumps and tubes used in standard range.

# Propane gives light brown reading with very indistinct endpoint, butane gives moderately sharp endpoint, and pentane and hexane give sharp endpoints.

Other Possible Interferences: Other hydrocarbons

# Carbon Dioxide CO<sub>2</sub>

No. H-10-104-30

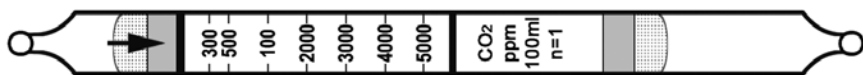

	Extended Range	Standard Range	Extended Range
Range (ppmv)	150 - 2500	300 - 5000	600 - 10000
No. of Pump Strokes	2	1	0.5
Sample Volume (mL)	200	100	50
Sample Time (min)	2 x 2	2	1.5
Correction Factor	0.5	1	2.3

Precision (Relative Standard Deviation)\*: ≤ ± 10%

Linearity with No. of Pump Strokes: r<sup>2</sup> = 0.993

Humidity: No effect 5 - 85% RH

Temperature Range: 0 - 40°C (32 - 104°F)

Temp (°C/°F)	0/32	10/50	21/70	40/104
Corr. Factor	0.90	0.95	1.0	0.95

Storage Life: 2 years in darkness at 5 - 25°C (40 - 77°F). Refrigeration preferred.

Color Change: White → Purple

Reaction Principle: CO<sub>2</sub> + H<sub>2</sub>NNH<sub>2</sub> → H<sub>2</sub>NNHCO<sub>2</sub>H (pH indicator change)

Cross-sensitivity: Substance	Concentration (ppmv)	Apparent Reading*
CO	3000	0
SO <sub>2</sub>	2050	500
SO <sub>2</sub>	200	~50
NO	100	0
NH <sub>3</sub>	50,000	0
H <sub>2</sub> S	2000	0
Hexane	1500	0
Isobutylene	100	0
Toluene	400	0

\* Data based on Honeywell pumps and tubes used in standard range.

Other Possible Interferences: Acid gases. Ammonia interferes in mixtures.



# Carbon Dioxide CO<sub>2</sub> No. H-10-104-40



	Extended Range	Standard Range	Extended Range
Range (%)	0.025 - 0.5%	0.05 - 1%	0.1 - 2%
No. of Pump Strokes	2	1	0.5
Sample Volume (mL)	200	100	50
Sample Time (min)	2 x 2	2	1.5
Correction Factor	0.5	1	2.3

Precision (Relative Standard Deviation)\*:  $\leq \pm 10\%$

Linearity with No. of Pump Strokes:  $r^2 = 0.994$

Humidity: No effect 5 - 85% RH

Temperature Range: 0 - 40°C (32 - 104°F)

Temp (°C/°F)	0/32	10/50	21/70	40/104
Corr. Factor	1.2	1.1	1.0	0.75

Storage Life: 2 years in darkness at 5 - 25°C (40 - 77°F). Refrigeration preferred.

Color Change: White → Purple

Reaction Principle:  $\text{CO}_2 + \text{H}_2\text{NNH}_2 \rightarrow \text{H}_2\text{NNHCO}_2\text{H}$  (pH indicator change)

Cross-sensitivity: Substance	Concentration (ppmv)	Apparent Reading*
CO	250	0
SO <sub>2</sub>	10	0.1%
NO	100	0
NH <sub>3</sub>	10%	0
CH <sub>4</sub>	2.5%	0
H <sub>2</sub> S	0.5%	0.1%
Hexane	1200	0
Isobutylene	100	0
Benzene	100	0
Toluene	400	0

\* Data based on Honeywell pumps and tubes used in standard range.

Other Possible Interferences: Acid gases. Ammonia interferes in mixtures.

# Carbon Dioxide CO<sub>2</sub> No. H-10-104-45

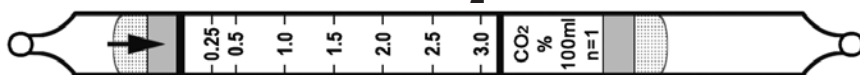

	Extended Range	Standard Range	Extended Range
Range (%)	0.125 - 1.5%	0.25 - 3%	0.5 - 6%
No. of Pump Strokes	2	1	0.5
Sample Volume (mL)	200	100	50
Sample Time (min)	2 x 2	2	1.5
Correction Factor	0.5	1	2.3

Precision (Relative Standard Deviation)\*: ≤ ± 10%

Linearity with No. of Pump Strokes: r<sup>2</sup> = 0.999

Humidity: No effect 5 - 85% RH

Temperature Range: 0 - 40°C (32 - 104°F)

Temp (°C/°F)	0/32	10/50	23/73	40/104
Corr. Factor	0.85	0.95	1.0	1.05

Storage Life: 2 years in darkness at 5 - 25°C (40 - 77°F). Refrigeration preferred.

Color Change: White → Purple

Reaction Principle: CO<sub>2</sub> + H<sub>2</sub>NNH<sub>2</sub> → H<sub>2</sub>NNHCO<sub>2</sub>H (pH indicator change)

<u>Cross-sensitivity:</u> Substance	Concentration (ppmv)	Apparent Reading*
CO	1.5%	0
SO <sub>2</sub>	5%	2.5%
SO <sub>2</sub>	200	0
NO	100	0
NH <sub>3</sub>	5%	0
CH <sub>4</sub>	2.5%	0
H <sub>2</sub> S	2000	0
Hexane	1500	0
Toluene	400	0

\* Data based on Honeywell pumps and tubes used in standard range.

Other Possible Interferences: Acid gases. Ammonia interferes in mixtures.

# Carbon Dioxide CO<sub>2</sub> No. H-10-104-50



	Extended Range	Extended Range	Standard Range
Range (%)	0.25 - 5%	0.5 - 10%	1 - 20%
No. of Pump Strokes	2	1	0.5
Sample Volume (mL)	200	100	50
Sample Time (min)	2 x 1.5	1.5	1
Correction Factor	0.25	0.5	1

Precision (Relative Standard Deviation)\*:  $\leq \pm 10\%$

Linearity with No. of Pump Strokes:  $r^2 \geq 0.999$

Humidity: No effect 5 - 100% RH

Temperature Range: No effect 0 - 40°C (32 - 104°F)

Storage Life: 2 years in darkness at 5 - 25°C (40 - 77°F). Refrigeration preferred.

Color Change: White → Purple

Reaction Principle:  $\text{CO}_2 + \text{H}_2\text{NNH}_2 \rightarrow \text{H}_2\text{NNHCO}_2\text{H}$  (pH indicator change)

<u>Cross-sensitivity:</u> Substance	Concentration (ppmv)	Apparent Reading*
CO	3000	0
SO <sub>2</sub>	200	0
NO	100	0
NH <sub>3</sub>	300	0
CH <sub>4</sub>	25000	0
H <sub>2</sub> S	100	0
Hexane	1200	0
Isobutylene	100	0
Toluene	100	0

\* Data based on Honeywell pumps and tubes used in standard range.

Other Possible Interferences: Acid gases

# Carbon Dioxide CO<sub>2</sub> No. H-10-104-60



	Extended Range	Extended Range	Standard Range
Range (%)	1.25 - 10%	2.5 - 20%	5 - 40%
No. of Pump Strokes	2	1	0.5
Sample Volume (mL)	200	100	50
Sample Time (min)	2 x 1.5	1.5	1
Correction Factor	0.33	0.6	1

**Precision (Relative Standard Deviation)\*:**  $\leq \pm 10\%$

**Humidity:** No effect 5 - 100% RH

**Temperature Range:** No effect 0 - 40°C (32 - 104°F)

**Storage Life:** 2 years in darkness at 5 - 25°C (40 - 77°F). Refrigeration preferred.

**Color Change:** White → Purple

**Reaction Principle:**  $\text{CO}_2 + \text{H}_2\text{NNH}_2 \rightarrow \text{H}_2\text{NNHCO}_2\text{H}$  (pH indicator change)

Cross-sensitivity: Substance	Concentration (ppmv)	Apparent Reading*
CO	40000	0
SO <sub>2</sub>	4000	0.5
NO	100	0
NH <sub>3</sub>	500	0
CH <sub>4</sub>	25000	0
H <sub>2</sub> S	10000	0
Hexane	1200	0
Isobutylene	100	0
Toluene	100	0

\* Data based on Honeywell pumps and tubes used in standard range.

**Other Possible Interferences:** Acid gases

# Carbon Monoxide CO No. H-10-102-18 (Selective)

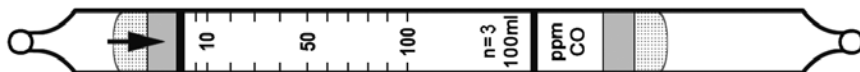

	Extended Range	Standard Range	Extended Range
Range (ppmv)	2.5 - 50	5 - 100	15 - 300
No. of Pump Strokes	6	3	1
Sample Volume (mL)	600	300	100
Sample Time (min)	6 x 2	3 x 2	2
Correction Factor	0.5	1	3.0

Precision (Relative Standard Deviation)\*:  $\leq \pm 15\%$

Linearity with No. of Pump Strokes:  $r^2 = 0.999$

Humidity: No effect 5 - 100% RH.

Temperature Range: No effect between 0 - 40°C (32 - 104°F)

Storage Life: 2 years in darkness at 5 - 25°C (40 - 77°F). Refrigeration preferred.

Color Change: White → Light Brown

Reaction Principle: Prelayer removes most interferences

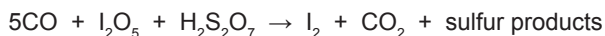

<u>Cross-sensitivity:</u> Substance	Concentration (ppmv)	Apparent Reading*
H <sub>2</sub>	100%	0
NO	100	0
H <sub>2</sub> S	50	0
NH <sub>3</sub>	300	0
CH <sub>4</sub>	25000	0
Hexane	100	12
Isobutylene	100	0
Toluene	100	0
Trichloroethylene	25	16**

\* Data based on Honeywell pumps and tubes used in standard range.

\*\*Very light blue.

Other Possible Interferences: Other hydrocarbons; most organic vapor interferences are eliminated by the pretreatment layer.

# Carbon Monoxide CO No. H-10-102-20

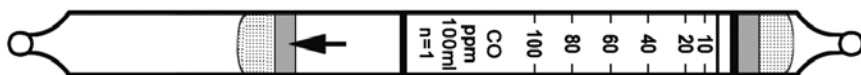

	Extended Range	Standard Range	Extended Range
Range (ppmv)	2.5 - 50	5 - 100	10 - 200
No. of Pump Strokes	2	1	0.5
Sample Volume (mL)	200	100	50
Sample Time (min)	2 x 2	2	1.5
Correction Factor	0.5	1	2

Precision (Relative Standard Deviation)\*:  $\leq \pm 12\%$

Linearity with No. of Pump Strokes:  $r^2 > 0.99$

Humidity: No effect 5 - 100% RH.

Temperature Range: 0 - 40°C (32 - 104°F)

Temp (°C/°F)	0/32	10/50	25/77	40/104
Corr. Factor	0.80	0.83	1.0	1.15

Storage Life: 2 years in darkness at 5 - 25°C (40 - 77°F). Refrigeration preferred.

Color Change: White → Light Brown Ring

Reaction Principle:  $5\text{CO} + \text{I}_2\text{O}_5 + \text{H}_2\text{S}_2\text{O}_7 \rightarrow \text{I}_2 + \text{CO}_2 + \text{sulfur products}$

<u>Cross-sensitivity:</u> Substance	Concentration (ppmv)	Apparent Reading*
NO	200	0
H <sub>2</sub> S	100	0
NH <sub>3</sub>	300	0
CH <sub>4</sub>	25000	0
Hexane	100	0
Isobutylene	100	0
Toluene	100	0
Trichloroethylene	25	20 (v faint)

\* Data based on Honeywell pumps and tubes used in standard range.

Other Possible Interferences: Most hydrocarbon interferences are eliminated in the pretreatment layer. Can be used to measure CO in pure hydrogen.

# Carbon Monoxide CO No. H-10-102-30

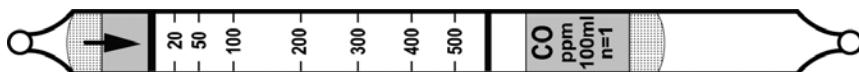

	Extended Range	Standard Range	Extended Range
Range (ppmv)	10-250	20 - 500	40 - 1000
No. of Pump Strokes	2	1	0.5
Sample Volume (mL)	200	100	50
Sample Time (min)	2 x 2	2	1.5
Correction Factor	0.5	1	2

Precision (Relative Standard Deviation)\*:  $\pm 15\%$

Linearity with No. of Pump Strokes:  $r^2 = 0.999$

Humidity: No effect 5 - 95% RH.

Temperature Range: No effect 0 - 40°C (32 - 104°F)

Storage Life: 2 years in darkness at 5 - 25°C (40 - 77°F). Refrigeration preferred.

Color Change: White → Light Brown

Reaction Principle: Prelayer removes most interferences

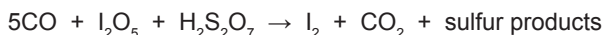

<u>Cross-sensitivity:</u> Substance	Concentration (ppmv)	Apparent Reading*
NO	200	0
H <sub>2</sub> S	100	0
NH <sub>3</sub>	300	0
CH <sub>4</sub>	25000	0
Hexane	100	0
Hexane	400	18
Isobutylene	100	0
Toluene	100	0
Trichloroethylene	25	15**

\* Data based on Honeywell pumps and tubes used in standard range.

\*\* Very light green.

Other Possible Interferences: Hydrocarbons and similar reducing gases.

# Carbon Monoxide CO No. H-10-102-45



	Extended Range	Standard Range	Extended Range
Range (%)	0.1 - 2%	0.2 - 4%	0.4 - 8%
No. of Pump Strokes	2	1	0.5
Sample Volume (mL)	200	100	50
Sample Time (min)	2 x 1.5	1.5	1
Correction Factor	0.5	1	2.0

Precision (Relative Standard Deviation)\*:  $\leq \pm 10\%$

Linearity with No. of Pump Strokes:  $r^2 = 0.999$

Humidity: No effect 5 - 100% RH.

Temperature Range: No effect 0 - 40°C (32 - 104°F)

Storage Life: 2 years in darkness at 5 - 25°C (40 - 77°F). Refrigeration preferred.

Color Change: White → Dark Brown

Reaction Principle:  $5\text{CO} + \text{I}_2\text{O}_5 + \text{H}_2\text{S}_2\text{O}_7 \rightarrow \text{I}_2 + \text{CO}_2 + \text{sulfur products}$

<u>Cross-sensitivity:</u> Substance	Concentration (ppmv)	Apparent Reading*
H <sub>2</sub> S	100	0
NH <sub>3</sub>	300	0
CH <sub>4</sub>	25000	0
Hexane	600	0.4%
Hexane	1200	1.2%
Isobutylene	100	0
Toluene	100	0

\* Data based on Honeywell pumps and tubes used in standard range.

Other Possible Interferences: Hydrocarbons and similar reducing gases.



# Chlorine Cl<sub>2</sub>

No. H-10-106-10

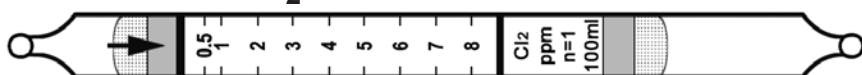

	Extended Range	Standard Range	Extended Range
Range (ppmv)	0.25 - 4	0.5 - 8	1.0 - 16
No. of Pump Strokes	2	1	0.5
Sample Volume (mL)	200	100	50
Sample Time (min)	2 x 2.5	2.5	2
Correction Factor	0.5	1	2

Precision (Relative Standard Deviation)\*: ≤±20%

Linearity with No. of Pump Strokes: r<sup>2</sup> = 0.99

Humidity: No data

Temperature Range: 0 - 40°C (32 - 104°F)

Temp (°C/°F)	0/32	10/50	18/70	40/104
Corr. Factor	ND	ND	1.0	ND

Storage Life: 1 year in darkness at 5 - 25°C (40 - 77°F). Refrigeration preferred.

Color Change: White → Yellow

Reaction Principle: Cl<sub>2</sub> + o-Tolidine → Yellow colored product + HCl

<u>Cross-sensitivity:</u> Substance	Concentration (ppmv)	Apparent Reading*
ClO <sub>2</sub>	1	2
CO <sub>2</sub>	15000	0
NH <sub>3</sub>	50000	0#
NO <sub>2</sub>	5	7
CH <sub>4</sub>	25000	0
H <sub>2</sub> S	250	0
Isobutylene	2000	0

\* Data based on Honeywell pumps and tubes used in standard range.

# Interferes in mixtures

Other Possible Interferences: Other oxidizing gases.

# Chlorine Cl<sub>2</sub>

No. H-10-106-20

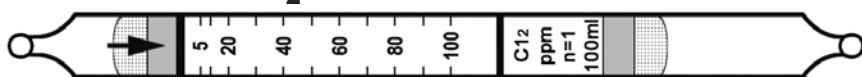

	Extended Range	Standard Range	Extended Range
Range (ppmv)	2.5 - 50	5 - 100	10 - 200
No. of Pump Strokes	2	1	0.5
Sample Volume (mL)	200	100	50
Sample Time (min)	2 x 2	2	1.5
Correction Factor	0.5	1	2

Precision (Relative Standard Deviation)\*:  $\leq \pm 20\%$

Linearity with No. of Pump Strokes:  $r^2 = 0.999$

Humidity: No effect 0-90% RH

Temperature Range: No effect between 0 - 40°C (32 - 104°F)

Storage Life: 1 year in darkness at 5 - 25°C (40 - 77°F). Refrigeration preferred.

Color Change: White → Orange

Reaction Principle: Cl<sub>2</sub> + o-Tolidine → Orange colored product + HCl

<u>Cross-sensitivity:</u> Substance	Concentration (ppmv)	Apparent Reading*
ClO <sub>2</sub>	10	9
CO	250	0
CO <sub>2</sub>	50000	0
NO	100	5
NH <sub>3</sub>	100	0
CH <sub>4</sub>	25000	0
H <sub>2</sub> S	10	0
SO <sub>2</sub>	2000	0
Hexane	100	0
Isobutylene	100	0
Toluene	100	0

\* Data based on Honeywell pumps and tubes used in standard range.

Other Possible Interferences: Other oxidizing gases.

# Chlorine Dioxide ClO<sub>2</sub>

No. H-10-130-10

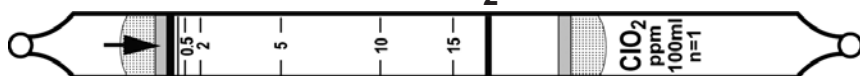

	Extended Range	Standard Range	Extended Range
Range (ppmv)	0.05 - 2	0.25 - 15	0.5-30
No. of Pump Strokes	5	1	0.5
Sample Volume (mL)	500	100	50
Sample Time (min)	5 x 2	2	1
Correction Factor	0.19	1	2.1

Precision (Relative Standard Deviation)\*:  $\pm 20\%$

Humidity: No effect 10-90% RH

Temperature Range: No effect 0 - 40°C (32 - 104°F)

Storage Life: 1 year in darkness at 5 - 25°C (40 - 77°F). Refrigeration preferred.

Color Change: White → Yellow

Reaction Principle: ClO<sub>2</sub> + o-Tolidine → Yellow colored product

<u>Cross-sensitivity:</u> Substance	Concentration (ppmv)	Apparent Reading*
Cl <sub>2</sub>	10	6
NO	25	2
NO <sub>2</sub>	5	11
NH <sub>3</sub>	50000	0
CH <sub>4</sub>	10000	0
HCl	1000	0
H <sub>2</sub> S	2000	0
CO	500	0
CO <sub>2</sub>	15000	0
Isobutylene	2000	0

\* Data based on Honeywell pumps and tubes used in standard range.

Other Possible Interferences: Bromine

# Diesel & Jet Fuel

No. H-10-143-10

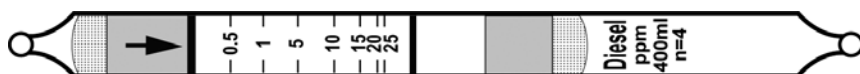

	Extended Range	Standard Range	Extended Range
Range (ppmv)	Do not extend	0.5 - 25	Do not extend
No. of Pump Strokes		4	
Sample Volume (mL)		400	
Sample Time (min)		4 x 1.5	
Correction Factor		1	

Precision (Relative Standard Deviation)\*:  $\leq \pm 20\%$  for undecane

Humidity: 0 - 95%RH

% RH	<5%	30%	50%	80%	95%
Corr. Factor	1.0	0.8	0.7	0.7	0.7

Temperature Range: 0 - 40°C (32 - 104°F)

Temp (°C/°F)	0/32	10/50	20/68	40/104
Corr. Factor	1.9	1.3	1.0	0.8

Storage Life: 1 year in darkness at 5 - 25°C (40 - 77°F). Refrigeration preferred.

Color Change: White → Brown-green Ring (Over-Range: White → Pale Yellow)

Reaction Principle:  $C_nH_m + I_2O_5 + H_2S_2O_7 \rightarrow I_2 + \text{Oxidation Products}$

**Continued on next page**

# Diesel & Jet Fuel (continued) No. H-10-143-10

Cross-sensitivity: Substance	Concentration (ppmv)	Apparent Reading*	Correction Factor
Undecane (C <sub>11</sub> H <sub>24</sub> )	25	25	1.0#
Diesel, whole (Automotive or Marine)	50	20	2.5
Diesel vapors	10	~20	~0.4
JP-5, whole (kerosene)	25	22	1.1
JP-8, whole (kerosene) †	10	11.5	0.87†
Gasoline, whole	25	10	2.5
CO <sub>2</sub>	10000	0	-
CO	10	10	1.0
CH <sub>4</sub>	25000	0	-
H <sub>2</sub> S	60	0	-
Butane	25	0	-
Propane	100	0	-
Hexane	25	0.5**	~50
Octane	5	10	0.5
Benzene	25	1**	~25
Toluene	25	0.5**	~50
Xylene	25	0.5	~50
Styrene	20	0.4	~50
Ethanol	2000	0	-
Isopropanol	200	0	-
Acetone	50	0	-

\* Data based on Honeywell pumps and tubes used in standard range.

# Calibrated to undecane.

\*\* Very faint brown stain.

† Can use 1 stroke @ CF =7.2 or 2 strokes @ CF = 2.5.

Other Possible Interferences: No response to 50 ppm HCl, or 100 ppm SO<sub>2</sub>, NH<sub>3</sub>, or NO<sub>2</sub>.

# Ethanol C<sub>2</sub>H<sub>5</sub>OH

No. H-10-141-30

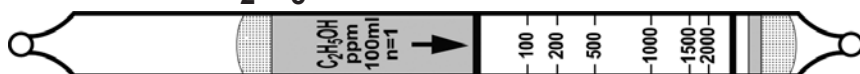

	Extended Range	Standard Range	Extended Range
Range (ppmv)	50-200 <sup>#</sup>	100 - 2000	Do not extend
No. of Pump Strokes	2	1	
Sample Volume (mL)	200	100	
Sample Time (min)	2 x 3	3	
Correction Factor	0.5 <sup>#</sup>	1	

<sup>#</sup> This CF only applies between 50-200 ppm; for higher concentrations use one stroke.

Precision (Relative Standard Deviation)\*: ≤±20%

Linearity with No. of Pump Strokes: r<sup>2</sup> = 0.87

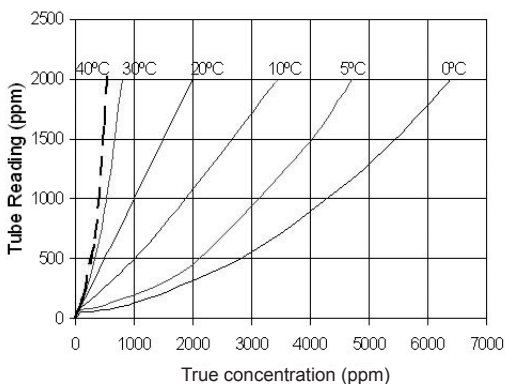

Humidity: No effect 0-95% RH

Temperature Range: 0 - 40°C (32 - 104°F)

Storage Life: 2 years in darkness at 5 - 25°C (40 - 77°F). Refrigeration preferred.

Color Change: Orange Yellow → Pale Green

Reaction Principle: C<sub>2</sub>H<sub>5</sub>OH + Cr(VI) + H<sub>2</sub>SO<sub>4</sub> → Cr(III) + Oxidation Products

**Continued on next page**

# Ethanol C<sub>2</sub>H<sub>5</sub>OH (continued) No. H-10-141-30

Cross-sensitivity: Substance	Concentration (ppmv)	Apparent Reading*	Correction Factor
Methanol	1000	1000	1.0
Isopropanol	1000	750	1.3
tert-Butanol	1000	1300	0.77
Methyl mercaptan	500	300	1.7
H <sub>2</sub> S	100	0	-
CH <sub>4</sub>	25000	0	-
CO <sub>2</sub>	5000	0	-
CO	1000	0	-
NH <sub>3</sub>	400	0	-
NO	100	130	0.77
Benzene	100	0	-
n-Hexane	100	0	-
Ethyl acetate	1000	0**	-

\* Data based on Honeywell pumps and tubes used in standard range.

\*\* Faint brown color over entire tube, but no effect on ethanol reading.

Other Possible Interferences: Other alcohols and mercaptans.

# Formaldehyde HCHO

No. H-10-121-05

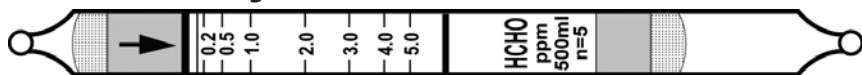

	Extended Range	Standard Range	Extended Range
Range (ppmv)	Do not extend	0.1 - 5	0.8 - 40
No. of Pump Strokes		5	1
Sample Volume (mL)		500	100
Sample Time (min)		5 x 2	2
Correction Factor		1	7.5

Precision (Relative Standard Deviation)\*:  $\pm 20\%$

Linearity with No. of Pump Strokes:  $r^2 > 0.995$

Humidity: 0 - 95% RH

% RH	<5%	30%	50%	80%
Corr. Factor	1.0	0.85	0.8	0.75

Temperature Range: 0 - 40°C (32 - 104°F)

Temp (°C/°F)	0/32	10/50	20/68	30/86	40/104
Corr. Factor	1.3	1.1	1.0	0.9	0.8

Storage Life: 2 years in darkness at 5 °C (40 - 77°F). Refrigeration preferred.

Color Change: Yellow → Reddish brown

Reaction Principle:  $3\text{HCHO} + (\text{NH}_2\text{OH})_3 \cdot \text{H}_3\text{PO}_4 \rightarrow \text{H}_3\text{PO}_4 + 3\text{H}_2\text{C}=\text{NOH} + 3\text{H}_2\text{O}$   
 $\text{H}_3\text{PO}_4 + \text{Base} \rightarrow \text{Phosphate (dye color change)}$

Cross-sensitivity: Substance	Concentration (ppmv)	Apparent Reading*
Acetaldehyde	3	3
Propionaldehyde	3	3
Acetone	3	Entire tube <sup>#</sup>
Methyl ethyl ketone	3	Entire tube <sup>#</sup>
CH <sub>4</sub>	25000	0
CO	500	0
CO <sub>2</sub>	1000	0
H <sub>2</sub> S	100	0
SO <sub>2</sub>	100	0
Hexane	2000	0
Toluene	100	0
Isobutylene	100	0.5
Isopropanol	2000	0
Phenol	25	0
Styrene	20	0

\* Data based on Honeywell pumps and tubes used in standard range.

<sup>#</sup> Faint brown color over entire stain length. 100 ppm gives stronger color.

Note: In dry air the background color may change: read only reddish-brown color.



# Gasoline



No. H-10-138-30

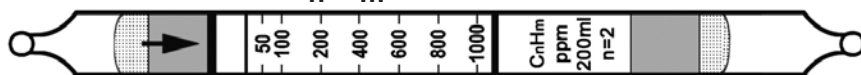

	Extended Range	Standard Range	Extended Range
Range (ppmv)	15 - 500	30 - 1000	60 - 2000
No. of Pump Strokes	4	2	1
Sample Volume (mL)	400	200	100
Sample Time (min)	4 x 2	2 x 2	2
Correction Factor	0.45	1	2.5

Precision (Relative Standard Deviation)\*: ≤±20%

Linearity with No. of Pump Strokes: r<sup>2</sup> = 0.999

Humidity: No effect 5 - 95% RH.

Temperature Range: 0 - 40°C (32 - 104°F)

Temp (°C/°F)	0/32	10/50	22/72	40/104
Corr. Factor	1.6	1.24	1.0	0.83

Storage Life: 2 years in darkness at 5 - 25°C(40 - 77°F). Refrigeration preferred.

Color Change: Orange → Dark Green

Reaction Principle: Prelayer removes humidity

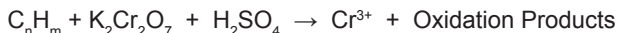

Cross-sensitivity: Substance	Concentration (ppmv)	Apparent Reading*
CH <sub>4</sub>	25000	0
CO	500	0
H <sub>2</sub> S	100	30
SO <sub>2</sub>	500	0
Acetone	1000	20
Ethanol	1000	20
Butane	1000	Entire tube
Isopar L	500	115
Toluene	200	80
Benzene	500	900

\* Data based on Honeywell pumps and tubes used in standard range.

Note: The tube is calibrated using heptane as a standard for gasoline.

# Total Hydrocarbons HC No. H-10-110-30

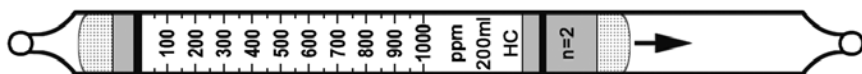

	Extended Range	Standard Range	Extended Range
Range (ppmv)	25 - 500	50 - 1000	100-2000
No. of Pump Strokes	4	2	1
Sample Volume (mL)	400	200	100
Sample Time (min)	4 x 2	2 x 2	2
Correction Factor	0.5	1	2

Precision (Relative Standard Deviation)\*:  $\leq \pm 20\%$

Linearity with No. of Pump Strokes:  $r^2 = 0.994$

Humidity: No effect 5 - 100% RH

Temperature Range: 0 - 40°C (32 - 104°F)

Temp (°C/°F)	0/32	10/50	25/77	40/104
Corr. Factor	1.2	1.1	1.0	0.85

Storage Life: 2 years in darkness at 5 - 25°C (40 - 77°F). Refrigeration preferred.

Color Change: Yellow-Orange → Green

Reaction Principle: HC + Cr(VI) + H<sub>2</sub>SO<sub>4</sub> → Cr(III) + Oxidation Products

Cross-sensitivity: Substance	Concentration (ppmv)	Apparent Reading*	Corr. Factor
Methane	25000	0	-
Ethylene	100	165	0.6
Propane	100	Entire tube faint	-
Isobutane	100	100	1.0
n-Pentane	500	700	0.7
n-Hexane	1200	870	1.4
n-Heptane	1000	525	1.9
n-Octane	400	103	3.9
n-Decane	1000	500	2.0
Benzene	500	Unclear endpoint	-
Toluene	1000	110	9
Xylene	1000	60	17
Isobutylene	1000	20	50
Acetone	10000	60	170
Isopropanol	1000	<20	>50
Ethyl Acetate	1000	<20	>50
H <sub>2</sub> S	1000	250	4.0

\* Data based on Honeywell pumps and tubes used in standard range.

Other Possible Interferences: No response to 3000 ppm CO, 300 ppm NH<sub>3</sub>, or 200 ppm SO<sub>2</sub>.

# Hydrogen Chloride HCl No. H-10-108-09

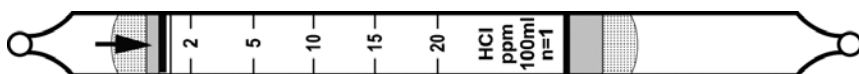

	Extended Range	Standard Range	Extended Range
Range (ppmv)	0.5 - 10	1 - 20	2 - 40
No. of Pump Strokes	2	1	0.5
Sample Volume (mL)	200	100	50
Sample Time (min)	2 x 1	1	0.5
Correction Factor	0.5	1	2

**Precision (Relative Standard Deviation)\*:**  $\leq \pm 20\%$

**Linearity with No. of Pump Strokes:**  $r^2 = 0.999$

**Humidity:** Must be used @  $< 5\%$  RH. Reading drops sharply above  $5\%$  RH.

**Temperature Range:** No effect between  $0 - 40^\circ\text{C}$  ( $32 - 104^\circ\text{F}$ ) at  $< 5\%$  RH.

**Storage Life:** 2 year in darkness at  $5 - 25^\circ\text{C}$  ( $40 - 77^\circ\text{F}$ ). Refrigeration preferred.

**Color Change:** Yellow  $\rightarrow$  Pink

**Reaction Principle:**  $\text{HCl} + \text{Base} \rightarrow \text{Chloride Salt} + \text{H}_2\text{O}$  (dye color change)

Cross-sensitivity: Substance	Concentration (ppmv)	Apparent Reading*
CO	15,000	0
CO <sub>2</sub>	8,000	0
H <sub>2</sub> S	800	0
SO <sub>2</sub>	200	0
NO	100	0
NO <sub>2</sub>	200	20
NH <sub>3</sub>	100	0
HF	25	15
Cl <sub>2</sub>	10	0
CH <sub>4</sub>	25,000	0
Hexane	2400	0
Toluene	400	0

\* Data based on Honeywell pumps and tubes used in standard range.

**Other Possible Interferences:** Other acid vapors; amines and other bases.

# Hydrogen Chloride HCl No.10-108-10

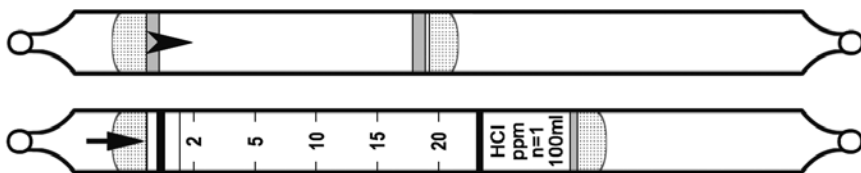

	Extended Range	Standard Range	Extended Range
Range (ppmv)	0.5 - 10	1 - 20	2 - 40
No. of Pump Strokes	2	1	0.5
Sample Volume (mL)	200	100	50
Sample Time (min)	2 x 1	1	0.5
Correction Factor	0.5	1	2

Precision (Relative Standard Deviation)\*:  $\leq \pm 20\%$

Linearity with No. of Pump Strokes:  $r^2 = 0.999$

Humidity: Calibrated at 50% RH and 23 °C (73 °F).

% Relative Humidity	< 5%	30%	50%	70%	90%
Correction Factor @ 10 ppmv	0.7	0.8	1.0	1.1	2.7

Temperature Range: No effect between 0 - 40°C (32 - 104°F) at <5% RH.

Storage Life: 2 years in darkness at 5 - 25°C (40 - 77°F). Refrigeration preferred.

Color Change: Yellow → Pink

Reaction Principle: Pretube reduces humidity  
 $\text{HCl} + \text{NaOH} \rightarrow \text{NaCl} + \text{H}_2\text{O}$  (dye color change)

Cross-sensitivity: Substance	Concentration (ppmv)	Apparent Reading*
CO	15,000	0
CO <sub>2</sub>	8,000	0
H <sub>2</sub> S	800	0
SO <sub>2</sub>	200	0
NO	100	0
NO <sub>2</sub>	200	20
NH <sub>3</sub>	100	0 <sup>^</sup>
HF	25	15
Cl <sub>2</sub>	10	>20
CH <sub>4</sub>	25,000	0
Hexane	2400	0
Toluene	400	0

\* Data based on Honeywell pumps and tubes used in standard range.

<sup>^</sup>Interferes in mixtures

Other Possible Interferences: Other acid vapors; amines and other bases.

# Hydrogen Chloride HCl No. H-10-108-22



	Extended Range	Standard Range	Extended Range
Range (ppmv)	10-250	20-500	40-1000
No. of Pump Strokes	2	1	0.5
Sample Volume (mL)	200	100	50
Sample Time (min)	2 x 1.5	1.5	1.0
Correction Factor	0.5	1	2.0

Precision (Relative Standard Deviation)\*:  $\leq \pm 20\%$

Linearity with No. of Pump Strokes:  $r^2 > 0.995$

Humidity: No effect 5-95% RH.

Temperature Range: No effect 0 - 40°C (32 - 104°F); at -20°C, the response is reduced by about 5%.

Storage Life: 2 years in darkness at 5 °C (40°F). Refrigeration required.

Color Change: Yellow → Red

Reaction Principle: HCl + Base → Chloride (dye color change)

<u>Cross-sensitivity:</u> Substance	Concentration (ppmv)	Apparent Reading*
CH <sub>4</sub>	25000	0
CO	500	0
CO <sub>2</sub>	1000	0
H <sub>2</sub> S	100	0
SO <sub>2</sub>	1000	0
NO	200	0
NO <sub>2</sub>	100	0
NH <sub>3</sub>	100	0
HF	100	0
Cl <sub>2</sub>	200	0
Hexane	2000	0
Toluene	2000	0

\* Data based on Honeywell pumps and tubes used in standard range.

# Hydrogen Cyanide HCN No. H-10-126-10

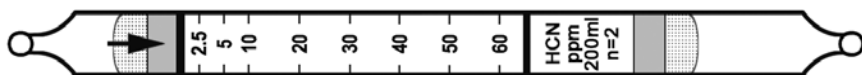

	Extended Range	Standard Range	Extended Range
Range (ppmv)	1.25 - 30	2.5 - 60	5 - 120
No. of Pump Strokes	4	2	1
Sample Volume (mL)	400	200	100
Sample Time (min)	4 x 2.5	2 x 2.5	2.5
Correction Factor	0.4	1	2

Precision (Relative Standard Deviation)\*:  $\leq \pm 20\%$

Linearity with No. of Pump Strokes:  $r^2 > 0.999$

Humidity: 5% - 95%RH

% Relative Humidity	< 5%	10%	50%	95%
Correction Factor @ 10 ppmv	1.0	1.0	1.2	1.4

Temperature Range: No effect 0 - 40°C (32 - 104°F)

Storage Life: 1 year in darkness at 5 - 25°C (40 - 77°F). Refrigeration preferred.

Color Change: Yellow → Red (ignore light orange color formed in clean air)

Reaction Principle:  $2\text{HCN} + \text{HgCl}_2 \rightarrow \text{Hg}(\text{CN})_2 + 2\text{HCl}$

$\text{HCl} + \text{Base} \rightarrow \text{Chloride Salt} + \text{H}_2\text{O}$  (dye color change)

<u>Cross-sensitivity:</u> Substance	Concentration (ppmv)	Apparent Reading*
H <sub>2</sub>	2000	0
CH <sub>4</sub>	25000	0
CO	300	0
H <sub>2</sub> S	100	<1#
HCl	100	<1#
SO <sub>2</sub>	20	20#
NH <sub>3</sub>	50	0
CO <sub>2</sub>	5000	0

\* Data based on Honeywell pumps and tubes used in standard range.

# Measured in dry gas; at >20% RH, no response is observed by these gases.

**Note:** A light orange color may form when drawing in air with no HCN present. This color can be ignored and does not affect true HCN readings, which form a bright pinkish-red color. The color boundary is sharp in ambient, humid air and somewhat diffuse in very dry air.

# Hydrogen Fluoride HF No. H-10-105-10

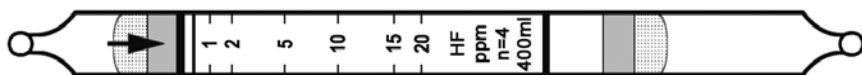

	Extended Range	Standard Range	Extended Range
Range (ppmv)	0.25 - 10	0.5 - 20	1 - 40
No. of Pump Strokes	8	4	2
Sample Volume (mL)	800	400	200
Sample Time (min)	8 x 0.5	4 x 0.5	2 x 0.5
Correction Factor	0.4	1	1.6

Precision (Relative Standard Deviation)\*:  $\leq \pm 20\%$

Linearity with No. of Pump Strokes:  $r^2 = 0.98$

Humidity: Calibrated at 50% RH and 23°C (73°F).

% Relative Humidity	30%	40%	50%	60%	70%	80%	90%
Correction Factor	0.3	0.4	1.0	1.3	1.6	2.0	2.6

Temperature Range: No effect 10 - 30°C (50 - 86°F) at constant 41% RH.

Storage Life: 2 years in darkness at 5 - 25°C (40 - 77°F). Refrigeration Preferred.

Color Change: Beige → Purple

Reaction Principle:  $\text{HF} + \text{NaOH} \rightarrow \text{NaF} + \text{H}_2\text{O}$

Cross-sensitivity: Substance	Concentration (ppmv)	Apparent Reading*
CO	250	0
CO <sub>2</sub>	50000	0
NH <sub>3</sub>	300	0 <sup>^</sup>
NO	100	0
H <sub>2</sub> S	800	0
SO <sub>2</sub>	200	0
CH <sub>4</sub>	25000	0
HCl	4	entire tube <sup>#</sup>
Cl <sub>2</sub>	15	entire tube <sup>#</sup>

\* Data based on Honeywell pumps and tubes used in standard range.

<sup>#</sup> Pink color over entire tube length.

<sup>^</sup> May interfere in mixtures.

Other Possible Interferences: Other acid vapors; amines and other bases. No effect of 100 ppm toluene or 2400 ppm hexane.

# Hydrogen Sulfide H<sub>2</sub>S No. H-10-103-04

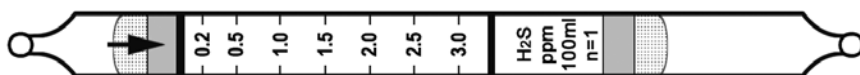

	Extended Range	Standard Range	Extended Range
Range (ppmv)	0.1 - 1.5	0.2 - 3	0.4 - 6
No. of Pump Strokes	2	1	0.5
Sample Volume (mL)	200	100	50
Sample Time (min)	2 x 1.5	1.5	1
Correction Factor	0.5	1	2

Precision (Relative Standard Deviation)\*:  $\leq \pm 12\%$

Linearity with No. of Pump Strokes:  $r^2 = 0.999$

Humidity: Tubes must be used @ <5% RH. Reading drops sharply above 5% RH.

Temperature Range: No effect between 0 - 40°C (32 - 104°F).

Storage Life: 1 year in darkness at 5 - 25°C (40 - 77°F). Refrigeration preferred.

Color Change: Pale orange → Pink

Reaction Principle:  $H_2S + HgCl_2 \rightarrow$  Mercury sulfide product + HCl  
 $HCl + Base \rightarrow$  Chloride Salt + H<sub>2</sub>O (dye color change)

<u>Cross-sensitivity:</u> Substance	Concentration (ppmv)	Apparent Reading*
Methyl mercaptan	2	0.4
Butyl mercaptan	2	0.3
NH <sub>3</sub>	100	0
NO <sub>2</sub>	5	0
SO <sub>2</sub>	100	0
CS <sub>2</sub>	100	0
CO	250	0
Hexane	100	0
Isobutylene	100	0 <sup>^</sup>
Toluene	100	0

\* Data based on Honeywell pumps and tubes used in standard range.

<sup>^</sup> Reduces response when mixed with H<sub>2</sub>S.

Other Possible Interferences: HCl and other acids and bases.



# Hydrogen Sulfide H<sub>2</sub>S No. H-10-103-05

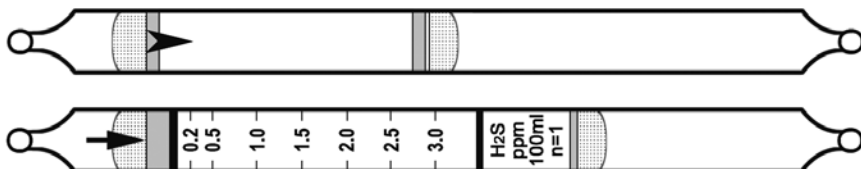

	Extended Range	Standard Range	Extended Range
Range (ppmv)	0.1 - 1.5	0.2 - 3	0.4 - 6
No. of Pump Strokes	2	1	0.5
Sample Volume (mL)	200	100	50
Sample Time (min)	2 x 2	2	1
Correction Factor	0.5	1	2

Precision (Relative Standard Deviation)\*:  $\pm 12\%$

Linearity with No. of Pump Strokes:  $r^2 = 0.999$

Humidity: No effect between 5 - 90% RH.

Temperature Range: No effect between 0 - 40°C (32 - 104°F).

Storage Life: 1 year in darkness at 5 - 25°C (40 - 77°F). Refrigeration preferred.

Color Change: Pale orange → Pink

Reaction Principle: Pretube eliminates humidity



Cross-sensitivity: Substance	Concentration (ppmv)	Apparent Reading*
Methyl mercaptan	3	0 <sup>#</sup>
Butyl mercaptan	3	0 <sup>#</sup>
NH <sub>3</sub>	100	0
NO <sub>2</sub>	5	0
SO <sub>2</sub>	100	0
CS <sub>2</sub>	100	0
CO	250	0
Hexane	100	0
Isobutylene	100	0 <sup>^</sup>
Toluene	100	0

\* Data based on Honeywell pumps and tubes used in standard range.

<sup>#</sup> Interferes at higher concentrations.

<sup>^</sup> Reduces response when mixed with H<sub>2</sub>S.

Other Possible Interferences: Acids and bases.

# Hydrogen Sulfide H<sub>2</sub>S No. H-10-103-06

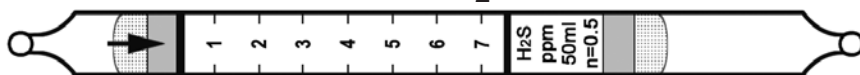

	Extended Range	Extended Range	Standard Range
Range (ppmv)	0.25 – 1.75	0.5 – 3.5	1 - 7
No. of Pump Strokes	2	1	0.5
Sample Volume (mL)	200	100	50
Sample Time (min)	2 x 1.5	1.5	1
Correction Factor	0.25	0.5	1

**Precision (Relative Standard Deviation)\*:** ≤±12%

**Humidity:** Tubes must be used @ <5% RH. Reading drops sharply above 5% RH.

**Temperature Range:** No effect between 0 - 40°C (32 - 104°F).

**Storage Life:** 1 year in darkness at 5 - 25°C (40 - 77°F). Refrigeration preferred.

**Color Change:** Pale orange → Pink

**Reaction Principle:** H<sub>2</sub>S + HgCl<sub>2</sub> → Mercury sulfide product + HCl  
 HCl + Base → Chloride Salt + H<sub>2</sub>O (dye color change)

Cross-sensitivity: Substance	Concentration (ppmv)	Apparent Reading*
Methyl mercaptan	2	0.2
Butyl mercaptan	2	0.15
NH <sub>3</sub>	100	0
NO <sub>2</sub>	5	0
SO <sub>2</sub>	100	0
SO <sub>2</sub>	2000	0 <sup>#</sup>
CS <sub>2</sub>	100	0
CO	250	0
Hexane	100	0
Isobutylene	100	0 <sup>^</sup>
Toluene	100	0

\* Data based on Honeywell pumps and tubes used in standard range.

<sup>#</sup> Forms orange color over entire tube but pink H<sub>2</sub>S reading is unaffected in mixtures.

<sup>^</sup> Reduces response when mixed with H<sub>2</sub>S.

**Other Possible Interferences:** HCl and other acids and bases.

# Hydrogen Sulfide H<sub>2</sub>S No. H-10-103-10

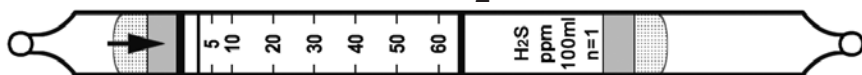

	Extended Range	Standard Range	Extended Range
Range (ppmv)	1.25 - 30	2.5 - 60	5 - 120
No. of Pump Strokes	2	1	0.5
Sample Volume (mL)	200	100	50
Sample Time (min)	2 x 1.5	1.5	1
Correction Factor	0.5	1	2

**Precision (Relative Standard Deviation)\*:**  $\leq \pm 12\%$

**Linearity with No. of Pump Strokes:**  $r^2 = 0.998$

**Humidity:** No effect 5 - 85% RH

**Temperature Range:** 0 - 40°C (32 - 104°F)

Temp (°C/°F)	0/32	10/50	25/77	40/104
Corr. Factor	0.95	0.95	1.0	1.2

**Storage Life:** 1 year in darkness at 5 - 25°C (40 - 77°F). Refrigeration preferred.

**Color Change:** White → Light Brown

**Reaction Principle:**  $H_2S + Pb(OAc)_2 \rightarrow PbS + 2HOAc$

Cross-sensitivity: Substance	Concentration (ppmv)	Apparent Reading*
H <sub>2</sub>	100%	0 <sup>^</sup>
CO	250	0
CH <sub>4</sub>	25000	0
NH <sub>3</sub>	300	0
NO <sub>2</sub>	200	0 <sup>‡</sup>
SO <sub>2</sub>	20	0
SO <sub>2</sub>	1800	0 <sup>†</sup>
CS <sub>2</sub>	100	0
Methyl mercaptan	100	0 <sup>#</sup>
Diethyl sulfide	100	0
Hexane	100	0
Isobutylene	100	0 <sup>^</sup>
Toluene	100	0

\* Data based on Honeywell pumps and tubes used in standard range.

<sup>^</sup> No effect in mixtures.

<sup>‡</sup> Interferes in mixtures; may result in transient light brown H<sub>2</sub>S response.

<sup>†</sup> Interferes in mixtures; high SO<sub>2</sub> concentrations suppress H<sub>2</sub>S response.

<sup>#</sup> Concentrations in the high % range leave a yellow color over the entire tube.

# Hydrogen Sulfide $H_2S$ No. H-10-103-12



	Extended Range	Standard Range	Extended Range
Range (ppmv)	0 - 75	0 - 150	0 - 300
No. of Pump Strokes	2	1	0.5
Sample Volume (mL)	200	100	50
Sample Time (min)	2 x 1.5	1.5	1
Correction Factor	0.5	1	2

Precision (Relative Standard Deviation)\*:  $\leq \pm 12\%$

Linearity with No. of Pump Strokes:  $r^2 = 0.999$

Humidity: No effect 5 - 85% RH

Temperature Range: 0 - 40°C (32 - 104°F)

Temp (°C/°F)	0/32	10/50	24/75	40/104
Corr. Factor	0.88	0.96	1.0	1.1

Storage Life: 2 years in darkness at 5 - 25°C (40 - 77°F). Refrigeration preferred.

Color Change: White → Brown

Reaction Principle:  $H_2S + Pb(OAc)_2 \rightarrow PbS + 2HOAc$

Cross-sensitivity: Substance	Concentration (ppmv)	Apparent Reading*
CO	250	0
CH <sub>4</sub>	25000	0
NH <sub>3</sub>	100	0
NO <sub>2</sub>	200	0 <sup>‡</sup>
CS <sub>2</sub>	100	0
Methyl mercaptan	1000	0 <sup>#</sup>
Diethyl sulfide	100	0
Isobutylene	100	0
Toluene	100	0

\* Data based on Honeywell pumps and tubes used in standard range.

<sup>‡</sup> Interferes in mixtures; may result in transient light brown  $H_2S$  response.

<sup>#</sup> No effect in mixtures. Concentrations in the high % range leave a yellow color over the entire tube.

# Hydrogen Sulfide $H_2S$ No. H-10-103-15

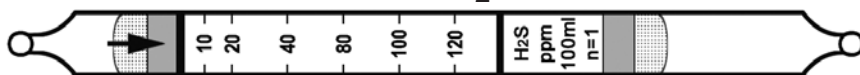

	Extended Range	Standard Range	Extended Range
Range (ppmv)	5 - 60	10 - 120	20 - 240
No. of Pump Strokes	2	1	0.5
Sample Volume (mL)	200	100	50
Sample Time (min)	2 x 1.5	1.5	1
Correction Factor	0.5	1	2

**Precision (Relative Standard Deviation)\*:**  $\leq \pm 12\%$

**Linearity with No. of Pump Strokes:**  $r^2 = 0.999$

**Humidity:** No effect 5 - 85% RH

**Temperature Range:** 0 - 40°C (32 - 104°F)

Temp (°C/°F)	0/32	10/50	24/75	40/104
Corr. Factor	0.88	0.96	1.0	1.1

**Storage Life:** 2 years in darkness at 5 - 25°C (40 - 77°F). Refrigeration preferred.

**Color Change:** White → Brown

**Reaction Principle:**  $H_2S + Pb(OAc)_2 \rightarrow PbS + 2HOAc$

Cross-sensitivity: Substance	Concentration (ppmv)	Apparent Reading*
CO	250	0
CH <sub>4</sub>	25000	0
NH <sub>3</sub>	100	0
NO <sub>2</sub>	200	0 <sup>‡</sup>
CS <sub>2</sub>	100	0
Methyl mercaptan	1000	0 <sup>#</sup>
Diethyl sulfide	100	0
Isobutylene	100	0
Toluene	100	0

\* Data based on Honeywell pumps and tubes used in standard range.

‡ Interferes in mixtures; may result in transient light brown  $H_2S$  response.

# No effect in mixtures. Concentrations in the high % range leave a yellow color over the entire tube.

# Hydrogen Sulfide H<sub>2</sub>S No. H-10-103-18

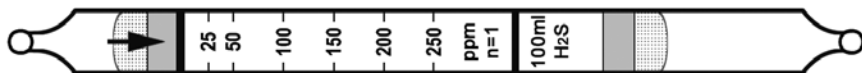

	Extended Range	Standard Range	Extended Range
Range (ppmv)	12.5 - 125	25 - 250	50 - 500
No. of Pump Strokes	2	1	0.5
Sample Volume (mL)	200	100	50
Sample Time (min)	2 x 1	1	1
Correction Factor	0.5	1	2

Precision (Relative Standard Deviation)\*:  $\pm 12\%$

Linearity with No. of Pump Strokes:  $r^2 = 0.999$

Humidity: No effect 5 - 85% RH

Temperature Range: 0 - 40°C (32 - 104°F)

Temp (°C/°F)	0/32	10/50	23/73	40/104
Corr. Factor	0.9	0.9	1.0	1.1

Storage Life: 2 years in darkness at 5 - 25°C (40 - 77°F). Refrigeration preferred.

Color Change: White → Brown

Reaction Principle:  $\text{H}_2\text{S} + \text{Pb}(\text{OAc})_2 \rightarrow \text{PbS} + 2\text{HOAc}$

Cross-sensitivity: Substance	Concentration (ppmv)	Apparent Reading*
CO	250	0
CH <sub>4</sub>	25000	0
NH <sub>3</sub>	100	0
NO <sub>2</sub>	200	0 <sup>†</sup>
CS <sub>2</sub>	100	0
Methyl mercaptan	500	0 <sup>#</sup>
Diethyl sulfide	100	0
Isobutylene	100	0
Toluene	100	0

\* Data based on Honeywell pumps and tubes used in standard range.

<sup>†</sup> Interferes in mixtures; may result in transient brown H<sub>2</sub>S response.

<sup>#</sup> Concentrations in the high % range leave a yellow color over the entire tube.

# Hydrogen Sulfide H<sub>2</sub>S No. H-10-103-20

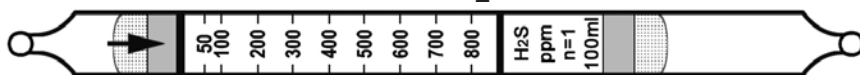

	Extended Range	Standard Range	Extended Range
Range (ppmv)	25 - 400	50 - 800	100 - 1600
No. of Pump Strokes	2	1	0.5
Sample Volume (mL)	200	100	50
Sample Time (min)	2 x 2	2	1.5
Correction Factor	0.5	1	2

**Precision (Relative Standard Deviation)\*:**  $\leq \pm 10\%$

**Linearity with No. of Pump Strokes:**  $r^2 = 0.989$

**Humidity:** 80% RH reduces the reading by about 10% compared to dry air

**Temperature Range:** 0 - 40°C (32 - 104°F)

Temp (°C/°F)	0/32	10/50	25/77	40/104
Corr. Factor	1.0	1.0	1.0	1.2

**Storage Life:** 2 years in darkness at 5 - 25°C (40 - 77°F). Refrigeration preferred.

**Color Change:** White → Dark Brown

**Reaction Principle:**  $\text{H}_2\text{S} + \text{Pb}(\text{OAc})_2 \rightarrow \text{PbS} + 2\text{HOAc}$

Cross-sensitivity: Substance	Concentration (ppmv)	Apparent Reading*
CO	250	0
CH <sub>4</sub>	25000	0
NH <sub>3</sub>	300	0
NO <sub>2</sub>	200	0 <sup>‡</sup>
SO <sub>2</sub>	20	0
CS <sub>2</sub>	100	0
Methyl mercaptan	500	<50
Diethyl sulfide	1000	0
Hexane	100	0
Isobutylene	100	0
Toluene	100	0

\* Data based on Honeywell pumps and tubes used in standard range.

‡ Interferes in mixtures; may result in transient brown H<sub>2</sub>S response.

# Hydrogen Sulfide $H_2S$ No. H-10-103-30

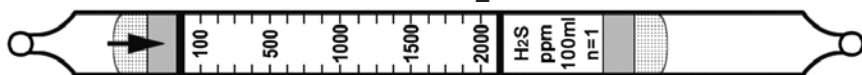

	Extended Range	Standard Range	Extended Range
Range (ppmv)	50 - 1000	100 - 2000	200 - 4000
No. of Pump Strokes	2	1	0.5
Sample Volume (mL)	200	100	50
Sample Time (min)	2 x 2	2	1.5
Correction Factor	0.5	1	2

**Precision (Relative Standard Deviation)\*:**  $\leq \pm 10\%$

**Linearity with No. of Pump Strokes:**  $r^2 = 0.999$

**Humidity:** No effect 5 - 85% RH

**Temperature Range:** 0 - 40°C (32 - 104°F)

Temp (°C/°F)	0/32	10/50	25/77	40/104
Corr. Factor	0.88	0.93	1.0	1.2

**Storage Life:** 2 years in darkness at 5 - 25°C (40 - 77°F). Refrigeration preferred.

**Color Change:** White → Black

**Reaction Principle:**  $H_2S + Pb(OAc)_2 \rightarrow PbS + 2HOAc$

Cross-sensitivity: Substance	Concentration (ppmv)	Apparent Reading*
CO	250	0
CH <sub>4</sub>	25000	0
NH <sub>3</sub>	300	0
NO <sub>2</sub>	200	0 <sup>†</sup>
SO <sub>2</sub>	20	0
CS <sub>2</sub>	100	0
Hexane	100	0
Isobutylene	100	0
Toluene	100	0

\* Data based on Honeywell pumps and tubes used in standard range.

† Interferes in mixtures; may result in transient brown  $H_2S$  response.

**Other Possible Interferences:** No response to mercaptans and sulfides.



# Hydrogen Sulfide H<sub>2</sub>S No. H-10-103-40

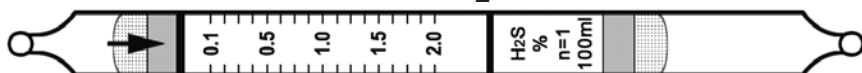

	Extended Range	Standard Range	Extended Range
Range (%)	0.05 - 1%	0.1 - 2%	0.2 - 4%
No. of Pump Strokes	2	1	0.5
Sample Volume (mL)	200	100	50
Sample Time (min)	2 x 2	2	1.5
Correction Factor	0.5	1	2

Precision (Relative Standard Deviation)\*:  $\leq \pm 10\%$

Linearity with No. of Pump Strokes:  $r^2 = 0.998$

Humidity: No effect 5 - 85% RH

Temperature Range: 0 - 40°C (32 - 104°F)

Temp (°C/°F)	0/32	18/64	25/77	40/104
Corr. Factor	1.2	1.1	1.0	1.0

Storage Life: 2 years in darkness at 5 - 25°C (40 - 77°F). Refrigeration preferred.

Color Change: Light Blue → Black

Reaction Principle:  $\text{H}_2\text{S} + \text{CuSO}_4 \rightarrow \text{CuS} + \text{H}_2\text{SO}_4$

Cross-sensitivity: Substance	Concentration (ppmv)	Apparent Reading*
CO	3000	0
CH <sub>4</sub>	25000	0
NO	100	0
NO <sub>2</sub>	200	0
NH <sub>3</sub>	300	0
SO <sub>2</sub>	20	0
Methyl mercaptan	0.1%	0.1%#
Diethyl sulfide	1000	0
Isobutylene	100	0
Toluene	100	0
Hexane	1200	0

\* Data based on Honeywell pumps and tubes used in standard range.

# Concentrations in the high % range leave a yellow color over the entire tube.

Other Possible Interferences: High Concentrations of ammonia; NO<sub>2</sub> in mixtures.

No response to CS<sub>2</sub>.

# Hydrogen Sulfide H<sub>2</sub>S No. H-10-103-50



	Extended Range	Extended Range	Standard Range
Range (%)	0.5 - 10%	1 - 20%	2 - 40%
No. of Pump Strokes	2	1	0.5
Sample Volume (mL)	200	100	50
Sample Time (min)	2 x 1.5	1.5	1.5
Correction Factor	0.25	0.5	1

Precision (Relative Standard Deviation)\*:  $\pm 10\%$

Linearity with No. of Pump Strokes:  $r^2 = 0.999$

Humidity: No effect 5 - 85% RH

Temperature Range: 0 - 40°C (32 - 104°F)

Temp (°C/°F)	0/32	10/50	18/64	40/104
Corr. Factor	0.75	1.0	1.0	1.0

Storage Life: 2 years in darkness at 5 - 25°C (40 - 77°F). Refrigeration preferred.

Color Change: Light Blue → Black

Reaction Principle:  $\text{H}_2\text{S} + \text{CuSO}_4 \rightarrow \text{CuS} + \text{H}_2\text{SO}_4$

Cross-sensitivity: Substance	Concentration (ppmv)	Apparent Reading*
CO	250	0
CO <sub>2</sub>	5%	0
NO	100	0
NH <sub>3</sub>	10%	3.5% (blue)
CH <sub>4</sub>	2.5%	0
SO <sub>2</sub>	10	0
Isobutylene	100	0
Hexane	100	0
Benzene	100	0
Toluene	100	0

\* Data based on Honeywell pumps and tubes used in standard range.

Other Possible Interferences: Mercaptans. No response to sulfides.

Note: Time measurement to exactly 2 minutes for best accuracy.

# Mercaptans RSH

No. H-10-129-20



	Extended Range	Standard Range	Extended Range
Range (ppmv)	2.5 - 60	5 - 120	10 - 240
No. of Pump Strokes	2	1	0.5
Sample Volume (mL)	200	100	50
Sample Time (min)	2 x 2.0	2.0	1.0
Correction Factor	0.5	1	2.1

Precision (Relative Standard Deviation)\*:  $\leq \pm 20\%$

Linearity with No. of Pump Strokes:  $r^2 = 0.999$

Humidity: No effect between 5 - 90% RH.

Temperature Range: No effect between 0 - 40°C (32 - 104°F)

Storage Life: 1 year in darkness at 5 - 25°C (40 - 77°F). Refrigeration preferred.

Color Change: White → Yellow

Reaction Principle:  $2\text{RSH} + \text{PdSO}_4 \rightarrow (\text{RS})_2\text{Pd} + \text{H}_2\text{SO}_4$

<u>Cross-sensitivity:</u> Substance	Concentration (ppmv)	Apparent Reading*	Corr. Factor
H <sub>2</sub> S	500	0 <sup>1</sup>	-
CO	500	0 <sup>2</sup>	-
Diethyl sulfide	5000	30 <sup>3</sup>	-
Ethyl mercaptan	60	60	1.0
Propyl mercaptan	60	60	1.0
Butyl mercaptan	60	29	2.0
Acetylene	2000	0 <sup>4</sup>	-
Ethylene	2000	0 <sup>5</sup>	-

\* Data based on Honeywell pumps and tubes used in standard range.

<sup>1</sup> Up to 500 ppm H<sub>2</sub>S is trapped in the pretreatment layer.

<sup>2</sup> Gray through the entire tube, will not affect RSH reading in mixtures.

<sup>3</sup> Interferes in mixtures; may result in high response.

<sup>4</sup> Pale brown through the entire tube, will not affect RSH reading in mixtures.

<sup>5</sup> Light peach through the entire tube, will not affect RSH reading in mixtures.

# Methyl Bromide CH<sub>3</sub>Br No. H-10-131-10

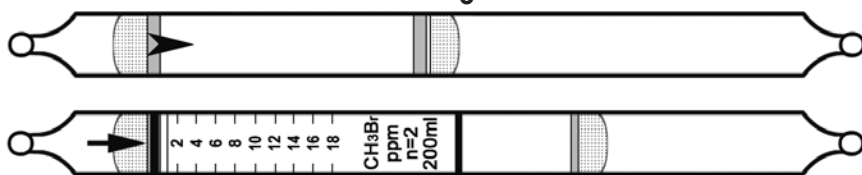

	Extended Range	Standard Range	Extended Range
Range (ppmv)	0.5-9	1-18	2-36
No. of Pump Strokes	4	2	1
Sample Volume (mL)	400	200	100
Sample Time (min)	4 x 3	2 x 3	3
Correction Factor	0.48	1.0	2.1

Precision (Relative Standard Deviation)\*:  $\leq \pm 20\%$

Linearity with No. of Pump Strokes:  $r^2 = 0.997$

Humidity: No effect 5 - 100% RH

Temperature Range: 0 - 40°C (32 - 104°F)

Temp (°C/°F)	0/32	10/40	25/77	40/104
Corr. Factor	1.5	1.3	1.0	0.95

Storage Life: 2 years in darkness at 5 - 25°C (40 - 77°F). Refrigeration preferred.

Color Change: White → Orange

Reaction Principle: Pre-tube :  $\text{CH}_3\text{Br} + \text{K}_2\text{Cr}_2\text{O}_7 + \text{H}_2\text{SO}_4 \rightarrow \text{Br}_2 + \text{Other Prods}$

Measurement Tube:  $\text{Br}_2 + \text{indicator dye} \rightarrow \text{Orange product}$

Cross-sensitivity: Substance	Concentration (ppmv)	Apparent Reading*
Tetrachloroethylene	200	13
Trichloroethylene	100	4
Vinylidene Chloride	200	47
Vinyl Chloride	200	5
3-Chloro-2-Methylpropene	200	4
1,2-Dichloroethane	200	0
1,1,1-Trichloroethane	50	4.5
Cl <sub>2</sub>	10	21
NO	500	0.6
NO <sub>2</sub>	570	1.0
CH <sub>4</sub>	25000	0
CO	500	0
CO <sub>2</sub>	5000	0

\* Data based on Honeywell pumps and tubes used in standard range.

Other Possible Interferences: No response to 500 ppm propane, 100 ppm isobutylene or 1200 ppm hexane.

# Methyl Bromide CH<sub>3</sub>Br No. H-10-131-30

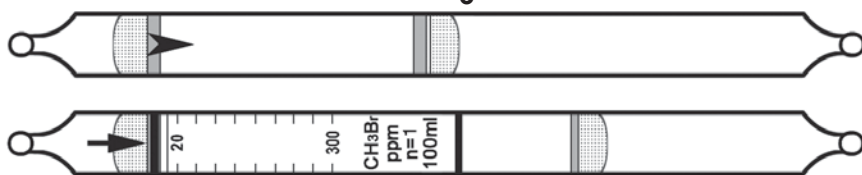

	Extended Range	Standard Range	Extended Range
Range (ppmv)	10-150	20-300	40-600
No. of Pump Strokes	2	1	0.5
Sample Volume (mL)	200	100	50
Sample Time (min)	2 x 2	2	2 x 0.5
Correction Factor	0.43	1	2.2

**Precision (Relative Standard Deviation)\*:**  $\leq \pm 15\%$

**Linearity with No. of Pump Strokes:** 0.999

**Humidity:** No effect 0 - 90% RH

**Temperature Range:** 0 - 40°C (32 - 104°F)

Temp (°C/°F)	0/32	10/50	20/68	30/86	40/104
Corr. Factor	1.7	1.3	1.0	0.8	0.7

**Storage Life:** 2 years in darkness at <10°C. Refrigeration preferred.

**Color Change:** White → Orange-yellow

**Reaction Principle:** Pretube:  $2\text{CH}_3\text{Br} + \text{I}_2\text{O}_5 + \text{H}_2\text{S}_2\text{O}_7 \rightarrow \text{Br}_2$   
 Measurement Tube:  $\text{Br}_2 + o\text{-Tolidine} \rightarrow \text{Orange-yellow product}$

Cross-sensitivity: Substance	Concentration (ppmv)	Apparent Reading*
1,2-Dibromoethane	300	600
1,3-Dibromopropane	600	700
1,1,1-Trichloroethane	300	30
Trichloroethylene	80	15
Cl <sub>2</sub>	80	63
Ethanol	10000	0
Ethyl acetate	10000	0
Acetone	10000	0
CH <sub>4</sub>	25000	0
CO <sub>2</sub>	5000	0
CO	500	0
H <sub>2</sub> S	500	0
SO <sub>2</sub>	100	0
NO	460	0
NO <sub>2</sub>	110	0

\* Data based on Honeywell pumps and tubes used in standard range.

# Methyl Ethyl Ketone C<sub>4</sub>H<sub>8</sub>O No. H-10-113-20

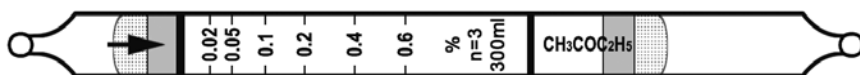

	Extended Range	Standard Range	Extended Range
Range (%)	0.01 - 0.3%	0.02 - 0.6%	0.06 - 1.8%
No. of Pump Strokes	6	3	1
Sample Volume (mL)	600	300	100
Sample Time (min)	6 x 2	3 x 2	2
Correction Factor	0.5	1	3

Precision (Relative Standard Deviation)\*: ≤±12%

Linearity with No. of Pump Strokes: r<sup>2</sup> = 0.996

Humidity: 85% RH increases the response by 15% compared to dry gas.

Temperature Range: 0 - 40°C (32 - 104°F)

Temp (°C/°F)	0/32	10/50	25/77	40/104
Corr. Factor	1.4	1.3	1.0	0.7

Storage Life: 2 years in darkness at 5 - 25°C (40 - 77°F). Refrigeration preferred.

Color Change: Orange → Black

Reaction Principle: CH<sub>3</sub>COCH<sub>2</sub>CH<sub>3</sub> + Cr(VI) + H<sub>2</sub>SO<sub>4</sub> → Cr(III) + Oxidation Prods.

Cross-sensitivity: Substance	Concentration (ppmv)	Apparent Reading*	Corr. Factor
Acetone	0.4%	0.5%	0.8
Methyl propyl ketone	1.0%	0.7%	1.4
Methyl isobutyl ketone	1.0%	0.49%	2.0
CO	1.5%	0	-
CO <sub>2</sub>	1.5%	0	-
CH <sub>4</sub>	2.5%	0	-
NH <sub>3</sub>	5.0%	>0.3% brown	-
H <sub>2</sub> S	250	0.2% diffuse <sup>#</sup>	-
Ethyl Acetate	1.0%	>0.3% diffuse <sup>#</sup>	-
Hexane	0.24%	entire tube <sup>#</sup>	-
Isobutylene	0.20%	0.5%	0.4
Toluene	400	0.3% diffuse <sup>#</sup>	-

\* Data based on Honeywell pumps and tubes used in standard range.

<sup>#</sup> Faint black color. Ketones can be distinguished by their darker stains and sharp endpoints.

Other Possible Interferences: Other hydrocarbons.

# Nitric Acid



No. H-10-146-20

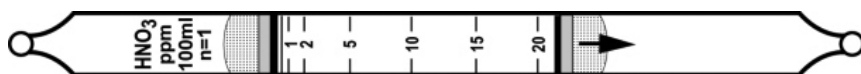

	Extended Range	Standard Range	Extended Range
Range (ppmv)	0.5-10	1-20	2-40
No. of Pump Strokes	2	1	0.5
Sample Volume (mL)	200	100	50
Sample Time (min)	2 x 1	1	0.5
Correction Factor	0.46	1	2.1

**Precision (Relative Standard Deviation)\*:**  $\leq \pm 20\%$

**Linearity with No. of Pump Strokes:**  $r^2 = 0.98$

**Humidity Range:** 0 - 90% RH. Calibrated at 50% RH and 20°C (68°F)

% Relative Humidity	0%	30%	50%	70%	80%	90%
Correction Factor	0.7	0.8	1.0	1.3	1.8	1.9

**Temperature Range:** 0 - 40°C (32 - 104°F)

Temp(°C/°F)	0/32	10/50	20/68	30/86	40/104
Corr. Factor	1.3	1.2	1.0	0.9	0.8

**Storage Life:** 2 years in darkness at 5 - 25°C (40 - 77°F). Refrigeration preferred.

**Color Change:** Yellow → Purple

**Reaction Principle:**  $\text{CH}_3\text{HNO}_3 + \text{Base} \rightarrow \text{Dye color change}$

Cross-sensitivity: Substance	Concentration (ppmv)	Apparent Reading*
HCl	10	14
Cl <sub>2</sub>	5	13
HF	10	7
Acetic Acid	saturated	$\leq 2$ (v. pale)
CO	250	0
CO <sub>2</sub>	50000	0
CH <sub>4</sub>	25000	0
NO	100	0
NO <sub>2</sub>	60	0
H <sub>2</sub> S	60	0
SO <sub>2</sub>	200	0
HCN	60	0

\* Data based on Honeywell pumps and tubes used in standard range.

**Other Possible Interferences:** Other acids may give a positive response and bases may give a negative response in mixtures. Headspace from 85% H<sub>3</sub>PO<sub>4</sub> and H<sub>2</sub>SO<sub>4</sub> give  $\leq 1$  ppm response because of their low volatility.

# Nitrogen Dioxide NO<sub>2</sub> No. H-10-117-10

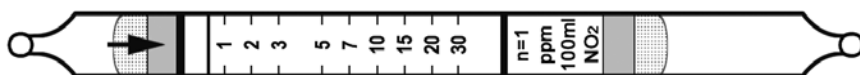

	Extended Range	Standard Range	Extended Range
Range (ppmv)	Do Not Extend	0.5-30	Do Not Extend
No. of Pump Strokes		1	
Sample Volume (mL)		100	
Sample Time (min)		1.5	
Correction Factor		1	

Precision (Relative Standard Deviation)\*:  $\pm 20\%$

Linearity with No. of Pump Strokes: Non-linear, do not extend

Humidity: No effect between 0-90%RH.

Temperature Range: No effect between 0 - 40°C (32 - 104°F)

Storage Life: 1 year in darkness at 5 - 25°C (40 - 77°F). Refrigeration preferred.

Color Change: White → Yellow

Reaction Principle: NO<sub>2</sub> + o-Tolidine → Nitrated yellow product

Cross-sensitivity: Substance	Concentration (ppmv)	Apparent Reading*
CO	3000	0
CO <sub>2</sub>	200000	0
SO <sub>2</sub>	200	0
CH <sub>4</sub>	25000	0
H <sub>2</sub> S	100	0
Acetone	10000	0
Benzene	5	0
n-Hexane	100	0
Isobutylene	100	0
Toluene	100	0
Cl <sub>2</sub>	50	Entire tube <sup>□</sup>
NO	500	1 <sup>#</sup>

\* Data based on Honeywell pumps and tubes used in standard range.

<sup>□</sup> Cl<sub>2</sub> results in light yellow stain.

<sup>#</sup> NO results in orange stain.

Other Possible Interferences: Reducing gases.



# Nitrogen Oxides NO<sub>x</sub>

(Separate Quantification)

No. H-10-109-20

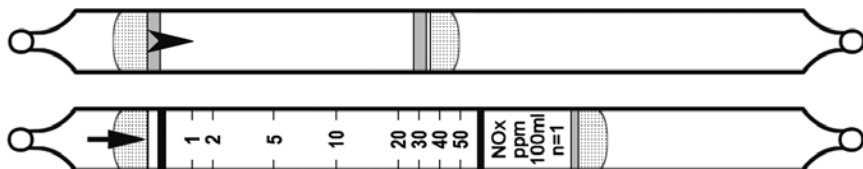

	Extended Range	Standard Range	Extended Range
Range (ppmv)	0.5 - 25	1-50	2-100
No. of Pump Strokes	2	1	0.5
Sample Volume (mL)	200	100	50
Sample Time (min)	2 x 3	3	2.5
Correction Factor	0.5	1	2

Precision (Relative Standard Deviation)\*:  $\leq \pm 20\%$

Linearity with No. of Pump Strokes:  $r^2 = 0.997$

Humidity: 100% RH reduces the response by about 20% vs. dry air

Temperature Range: 0 - 40°C (32 - 104°F)

Temp (°C/°F)	0/32	10/50	25/77	40/104
Corr. Factor	1.8	1.6	1.0	1.0

Storage Life: 1 year in darkness at 5 - 25°C (40 - 77°F). Refrigeration preferred.

Color Change: White → Yellow

Reaction Principle:  $\text{NO} + \text{CrO}_3 + \text{H}_2\text{SO}_4 \rightarrow \text{NO}_2$  Pre-tube

$\text{NO}_2 + o\text{-Tolidine} \rightarrow \text{Nitrated yellow product}$  Meas. tube

Cross-sensitivity: Substance	Concentration (ppmv)	Apparent Reading*
CO	3000	0
CO <sub>2</sub>	10%	0
SO <sub>2</sub>	200	0
CH <sub>4</sub>	25000	0
H <sub>2</sub> S	100	0
Acetone	10000	0

\* Data based on Honeywell pumps and tubes used in standard range.

Other Possible Interferences: Reducing gases. No response to 5 ppm benzene.

No response to 1200 ppm hexane, 100 ppm isobutylene, or 100 ppm toluene.

Separate Quantification: Sampling without the pre-tube gives NO<sub>2</sub> only. Using the pre-tube gives the sum of NO + NO<sub>2</sub>. NO can be obtained by difference.

# Ozone O<sub>3</sub>

No. H-10-133-03

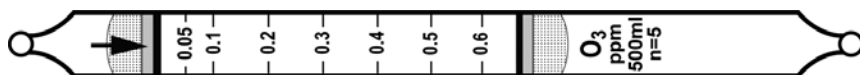

	Extended Range	Standard Range	Extended Range
Range (ppmv)	Do not extend	0.05 – 0.6	0.15 – 1.8
No. of Pump Strokes		5	1
Sample Volume (mL)		500	100
Sample Time (min)		5 x 2	2
Correction Factor		1	3

**Precision (Relative Standard Deviation)\*:** ≤±20%

**Linearity with No. of Pump Strokes:** r<sup>2</sup> = 0.990

**Humidity:** Calibration is based on approximately 50% relative humidity.

**Temperature Range:** 0 - 40°C (32 - 104°F)

Temp (°C/°F)	0/32	10/50	20/68	40/104
Corr. Factor	0.74	1.0	1.0	1.1

**Storage Life:** 1 year in darkness at 5 - 25°C (40 - 77°F). Refrigeration preferred.

**Color Change:** Blue → White

**Reaction Principle:**  $2O_3 + C_{16}H_{10}N_2O_2 \rightarrow 2C_8H_5NO_2 + 2O_2$

<u>Cross-sensitivity:</u> Substance	Concentration (ppmv)	Apparent Reading*
Cl <sub>2</sub>	<10	0
Cl <sub>2</sub>	≥10	~0.1 <sup>#</sup>
ClO <sub>2</sub>	1	entire tube <sup>#</sup>
CO	100	0
CO <sub>2</sub>	10,000	0
CH <sub>4</sub>	70,000	0
SO <sub>2</sub>	100	0
H <sub>2</sub> S	120	0
NO	5	0
NO <sub>2</sub>	1	0
Isobutylene	100	0

\* Data based on Honeywell pumps and tubes used in standard range.

<sup>#</sup>Slight discoloration and unclear demarcation.

**Other Possible Interferences:** Bromine and other oxidants.

# Phenol C<sub>6</sub>H<sub>5</sub>OH

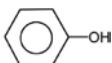

No. H-10-139-05

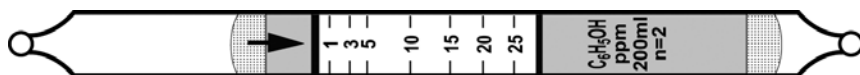

	Extended Range	Standard Range	Extended Range	Extended Range
Range (ppmv)	0.5 - 11	1 - 25	2.4 - 60	7 - 180
No. of Pump Strokes	4	2	1	0.5
Sample Volume (mL)	400	200	100	50
Sample Time (min)	4 x 1.5	2 x 1.5	1.5	1.0
Correction Factor	0.45	1	2.4	7.2

Precision (Relative Standard Deviation)\*:  $\leq \pm 20\%$

Linearity with No. of Pump Strokes:  $r^2 = 0.996$

### Humidity:

% Relative Humidity	10%	30%	50%	90%
Correction Factor	1.0	1.25	1.6	1.8

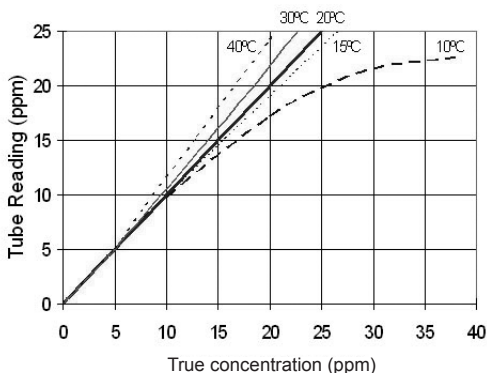

Temperature Range: 10 - 40°C (50 - 104°F)

Storage Life: 1.5 years in darkness at 5 - 25°C (40 - 77°F). Refrigeration preferred.

Color Change: Pale Yellow → Gray

Reaction Principle: C<sub>6</sub>H<sub>5</sub>OH + Ce(NH<sub>4</sub>)<sub>2</sub>(NO<sub>3</sub>)<sub>6</sub> → Cerium-Phenol complex

*Continued on next page*

# Phenol $C_6H_5OH$ (continued) No. H-10-139-05

Cross-sensitivity: Substance	Concentration (ppmv)	Apparent Reading*
H <sub>2</sub> S	100	0
NH <sub>3</sub>	500	0
NO	400	0
NO <sub>2</sub>	400	0
SO <sub>2</sub>	200	0
CH <sub>4</sub>	25000	0
CO <sub>2</sub>	5000	0
CO	500	0
Formaldehyde (HCHO)	500	0
Acetone	2000	0
Isopropanol	2000	0
Isobutylene	100	0
n-Hexane	2000	0
Benzene	2000	0
Toluene	2000	0
Styrene	2000	0

\* Data based on Honeywell pumps and tubes used in standard range.

# Phosphine PH<sub>3</sub>

No. H-10-116-10

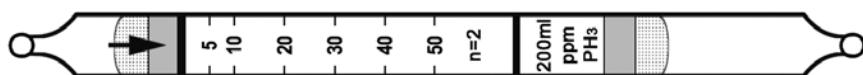

	Extended Range	Standard Range	Extended Range
Range (ppmv)	2.5 - 25	5 - 50	10 - 100
No. of Pump Strokes	4	2	1
Sample Volume (mL)	400	200	100
Sample Time (min)	4 x 1.5	2 x 1.5	1.5
Correction Factor	0.5	1	1.7

Precision (Relative Standard Deviation)\*:  $\leq \pm 12\%$

Linearity with No. of Pump Strokes:  $r^2 = 0.997$

Humidity: No effect 5 - 90% RH.

Temperature Range: 0 - 40°C (32 - 104°F)

Temp (°C/°F)	0/32	10/50	25/77	40/104
Corr. Factor	0.85	0.90	1.0	1.0

Storage Life: 1 year in darkness at 5 - 25°C (40 - 77°F). Refrigeration preferred.

Color Change: White → Yellow

Reaction Principle:  $2\text{PH}_3 + 6\text{HgCl}_2 + 3\text{H}_2\text{O} \rightarrow \text{Hg}_3\text{P}_2 \cdot 3\text{HgCl}_2 \cdot 3\text{H}_2\text{O} + 6\text{HCl}$

<u>Cross-sensitivity:</u> Substance	Concentration (ppmv)	Apparent Reading*
H <sub>2</sub> S	50	28 (l. brown)
SO <sub>2</sub>	200	0
NO	100	0
NH <sub>3</sub>	100	0
CO	100	0
CO <sub>2</sub>	50000	0
CH <sub>4</sub>	25000	0
Hexane	1500	0
Toluene	100	0

\* Data based on Honeywell pumps and tubes used in standard range.

Other Possible Interferences: Strongly reducing gases.

# Phosphine PH<sub>3</sub>

No. H-10-116-20

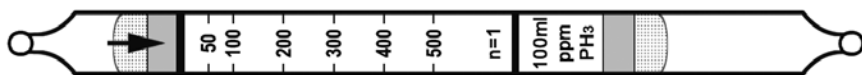

	Extended Range	Standard Range	Extended Range
Range (ppmv)	12.5 - 250	25 - 500	50 - 1000
No. of Pump Strokes	2	1	0.5
Sample Volume (mL)	200	100	50
Sample Time (min)	2 x 1.5	1.5	1
Correction Factor	0.5	1	2

Precision (Relative Standard Deviation)\*: ≤±12%

Linearity with No. of Pump Strokes:  $r^2 = 0.99$

Humidity: No effect 5 - 80% RH.

Temperature Range: 0 - 40°C (32 - 104°F)

Temp (°C/°F)	0/32	10/50	24/75	40/104
Corr. Factor	0.85	0.95	1.0	1.15

Storage Life: 1 year in darkness at 5 - 25°C (40 - 77°F). Refrigeration preferred.

Color Change: White → Yellow

Reaction Principle:  $2\text{PH}_3 + 6\text{HgCl}_2 + 3\text{H}_2\text{O} \rightarrow \text{Hg}_3\text{P}_2 \cdot 3\text{HgCl}_2 \cdot 3\text{H}_2\text{O} + 6\text{HCl}$

<u>Cross-sensitivity:</u> Substance	Concentration (ppmv)	Apparent Reading*
H <sub>2</sub> S	50	35 (brown)
SO <sub>2</sub>	200	0
NO	100	0
NH <sub>3</sub>	100	0
CO	250	0
CO <sub>2</sub>	50000	0
CH <sub>4</sub>	25000	0
Hexane	1500	0
Toluene	100	0

\* Data based on Honeywell pumps and tubes used in standard range.

Other Possible Interferences: Strongly reducing gases.

# Phosphine PH<sub>3</sub>

No. H-10-116-25

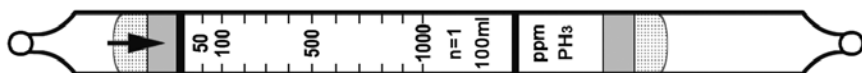

	Extended Range	Standard Range	Extended Range
Range (ppmv)	25 - 500	50 - 1000	100 - 2000
No. of Pump Strokes	2	1	0.5
Sample Volume (mL)	200	100	50
Sample Time (min)	2 x 1.5	1.5	1
Correction Factor	0.5	1	2

Precision (Relative Standard Deviation)\*:  $\leq \pm 10\%$

Linearity with No. of Pump Strokes:  $r^2 = 1.000$

Humidity: No effect 5 - 80% RH.

Temperature Range: No effect between 0-40°C (32 - 104°F)

Storage Life: 1 year in darkness at 5 - 25°C (40 - 77°F). Refrigeration preferred.

Color Change: White → Yellow

Reaction Principle:  $2\text{PH}_3 + 6\text{HgCl}_2 + 3\text{H}_2\text{O} \rightarrow \text{Hg}_3\text{P}_2 \cdot 3\text{HgCl}_2 \cdot 3\text{H}_2\text{O} + 6\text{HCl}$

<u>Cross-sensitivity:</u> Substance	Concentration (ppmv)	Apparent Reading*
H <sub>2</sub> S	200	140 †
SO <sub>2</sub>	3940	0
NO	100	0
NH <sub>3</sub>	100	0
CO	250	0
CO <sub>2</sub>	50000	0
CH <sub>4</sub>	25000	0
Hexane	1500	0
Toluene	100	0

\* Data based on Honeywell pumps and tubes used in standard range.

† Interferes in mixtures; may result in transient light brown H<sub>2</sub>S response.

Other Possible Interferences: Strongly reducing gases.

# Sulfur Dioxide SO<sub>2</sub> No. H-10-107-15

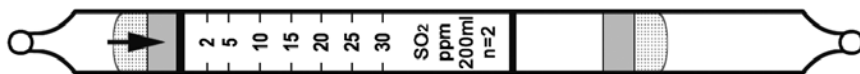

	Extended Range	Standard Range	Extended Range
Range (ppmv)	1 - 15	2 - 30	4 - 60
No. of Pump Strokes	4	2	1
Sample Volume (mL)	400	200	100
Sample Time (min)	4 x 2	2 x 2	2
Correction Factor	0.5	1	2

Precision (Relative Standard Deviation)\*:  $\leq \pm 12\%$

Linearity with No. of Pump Strokes:  $r^2 = 0.991$

Humidity: No effect 5 - 90% RH.

Temperature Range: 0 - 40°C (32 - 104°F)

Temp (°C/°F)	0/32	10/50	24/75	40/104
Corr. Factor	1.1	1.1	1.0	1.1

Storage Life: 2 years in darkness at 5 - 25°C (40 - 77°F). Refrigeration preferred.

Color Change: Blue-green → Yellow

Reaction Principle:  $\text{SO}_2 + 2\text{NaOH} \rightarrow \text{Na}_2\text{SO}_3 + \text{H}_2\text{O}$  (pH indicator change)

<u>Cross-sensitivity:</u> Substance	Concentration (ppmv)	Apparent Reading*
CO	15000	0
CO <sub>2</sub>	50000	0
NO	100	0
NH <sub>3</sub>	100	2 (blue) <sup>#</sup>
H <sub>2</sub> S	2000	3 (blue)
PH <sub>3</sub>	30	0
HF	50	0.5
CH <sub>4</sub>	25000	0
Hexane	1500	0
Toluene	400	0

\* Data based on Honeywell pumps and tubes used in standard range.

<sup>#</sup>Reduces reading in mixture.

Other Possible Interferences: Acid gases.



# Sulfur Dioxide SO<sub>2</sub>

No. H-10-107-20

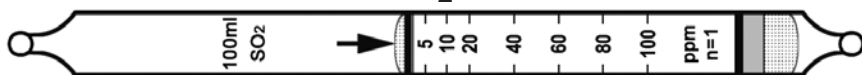

	Extended Range	Standard Range	Extended Range
Range (ppmv)	2.5 - 50	5 - 100	10 - 200
No. of Pump Strokes	2	1	0.5
Sample Volume (mL)	200	100	50
Sample Time (min)	2 x 2	2	1.5
Correction Factor	0.5	1	2

**Precision (Relative Standard Deviation)\*:**  $\leq \pm 12\%$

**Linearity with No. of Pump Strokes:**  $r^2 = 0.999$

**Humidity:** No effect 5 - 50% RH; 100% RH reduces the response by about 25%

**Temperature Range:** 0 - 40°C (32 - 104°F)

Temp (°C/°F)	0/32	10/50	25/77	40/104
Corr. Factor	1.2	1.0	1.0	1.0

**Storage Life:** 2 years in darkness at 5 - 25°C (40 - 77°F). Refrigeration preferred.

**Color Change:** Blue → Yellow

**Reaction Principle:**  $\text{SO}_2 + 2\text{NaOH} \rightarrow \text{Na}_2\text{SO}_3 + \text{H}_2\text{O}$  (pH indicator change)

<u>Cross-sensitivity:</u> Substance	Concentration (ppmv)	Apparent Reading*
CO	3000	0
CO <sub>2</sub>	10%	0
NO	100	0
NH <sub>3</sub>	300	0 <sup>#</sup>
CH <sub>4</sub>	25000	0
H <sub>2</sub> S	100	0
Isobutylene	100	0
Hexane	1200	0
Toluene	100	0
Acetone	10000	0

\* Data based on Honeywell pumps and tubes used in standard range.

<sup>#</sup>Reduces reading in mixture.

**Other Possible Interferences:** Acid gases.

# Sulfur Dioxide SO<sub>2</sub>

No. H-10-107-25

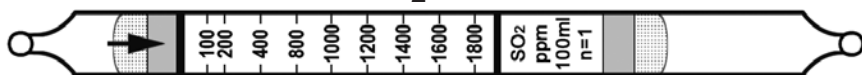

	Extended Range	Standard Range	Extended Range
Range (ppmv)	50 - 900	100 - 1800	200 - 3600
No. of Pump Strokes	2	1	0.5
Sample Volume (mL)	200	100	50
Sample Time (min)	2 x 2	2	1.5
Correction Factor	0.5	1	2

Precision (Relative Standard Deviation)\*:  $\leq \pm 10\%$

Linearity with No. of Pump Strokes:  $r^2 = 0.999$

Humidity: No effect 5 - 85% RH.

Temperature Range: 0 - 40°C (32 - 104°F)

Temp (°C/°F)	0/32	10/50	25/77	40/104
Corr. Factor	1.1	1.0	1.0	1.0

Storage Life: 2 years in darkness at 5 - 25°C (40 - 77°F). Refrigeration preferred.

Color Change: Blue → Yellow

Reaction Principle:  $\text{SO}_2 + 2\text{NaOH} \rightarrow \text{Na}_2\text{SO}_3 + \text{H}_2\text{O}$  (pH indicator change)

Cross-sensitivity: Substance	Concentration (ppmv)	Apparent Reading*
CO	3000	0
CO <sub>2</sub>	10%	0
NO	100	0
NH <sub>3</sub>	300	0 <sup>#</sup>
CH <sub>4</sub>	25000	0
H <sub>2</sub> S	100	0
Hexane	1200	0
Isobutylene	100	0
Toluene	100	0

\* Data based on Honeywell pumps and tubes used in standard range.

<sup>#</sup>Reduces reading in mixture.

Other Possible Interferences: Acid gases.

# Sulfur Dioxide SO<sub>2</sub>

No. H-10-107-30

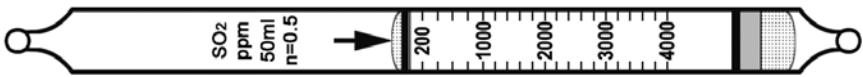

	Extended Range	Extended Range	Standard Range
Range (ppmv)	50 - 1000	100 - 2000	200 - 4000
No. of Pump Strokes	2	1	0.5
Sample Volume (mL)	200	100	50
Sample Time (min)	2 x 1	1	1
Correction Factor	0.25	0.5	1

Precision (Relative Standard Deviation)\*:  $\leq \pm 10\%$

Linearity with No. of Pump Strokes:  $r^2 = 0.999$

Humidity: No effect 5 - 50% RH; 100% RH reduces the response by about 40%

Temperature Range: 0 - 40°C (32 - 104°F)

Temp (°C/°F)	0/32	10/50	25/77	40/104
Corr. Factor	1.1	1.0	1.0	1.0

Storage Life: 2 years in darkness at 5 - 25°C (40 - 77°F). Refrigeration preferred.

Color Change: Blue → Yellow

Reaction Principle:  $\text{SO}_2 + 2\text{NaOH} \rightarrow \text{Na}_2\text{SO}_3 + \text{H}_2\text{O}$  (pH indicator change)

<u>Cross-sensitivity:</u> Substance	Concentration (ppmv)	Apparent Reading*
CO	3000	0
CO <sub>2</sub>	10%	0
NO	100	0
NH <sub>3</sub>	300	0 <sup>#</sup>
CH <sub>4</sub>	25000	0
H <sub>2</sub> S	100	0
Hexane	1200	0
Isobutylene	100	0
Toluene	100	0

\* Data based on Honeywell pumps and tubes used in standard range.

<sup>#</sup>Reduces reading in mixture.

Other Possible Interferences: Acid gases.

# Sulfur Dioxide SO<sub>2</sub>

No. H-10-107-40

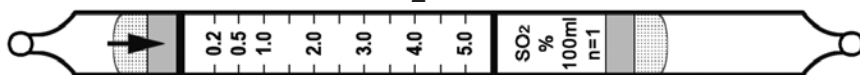

	Extended Range	Standard Range	Extended Range
Range (%)	0.1 – 2.5%	0.2 - 5%	0.4 - 10%
No. of Pump Strokes	2	1	0.5
Sample Volume (mL)	200	100	50
Sample Time (min)	2 x 2	2	1.5
Correction Factor	0.5	1	2

Precision (Relative Standard Deviation)\*:  $\leq \pm 10\%$

Linearity with No. of Pump Strokes:  $r^2 = 0.999$

Humidity: No effect 5 - 90% RH

Temperature Range: 0 - 40°C (32 - 104°F)

Temp (°C/°F)	0/32	10/50	25/77	40/104
Corr. Factor	1.15	1.0	1.0	1.0

Storage Life: 2 years in darkness at 5 - 25°C (40 - 77°F). Refrigeration preferred.

Color Change: Yellow → Green

Reaction Principle:  $\text{SO}_2 + \text{Cr(VI)} + \text{H}_2\text{O} \rightarrow \text{H}_2\text{SO}_4 + \text{Cr(III)}$

Cross-sensitivity: Substance	Concentration (ppmv)	Apparent Reading*
CO	3000	0
CO <sub>2</sub>	5%	0
NH <sub>3</sub>	5%	2.3% #
CH <sub>4</sub>	2.5%	0
H <sub>2</sub> S	50	0
Hexane	1500	0
Isobutylene	2000	0
Benzene	100	0

\* Data based on Honeywell pumps and tubes used in standard range.

#Forms a bright yellow color and reduces reading in mixture.

Other Possible Interferences: Reducing gases.

# Toluene C<sub>7</sub>H<sub>8</sub>



No. H-10-114-20



	Extended Range	Standard Range	Extended Range
Range (ppmv)	5 - 150	10 - 300	20 - 600
No. of Pump Strokes	2	1	0.5
Sample Volume (mL)	200	100	50
Sample Time (min)	2 x 2	2	1.5
Correction Factor	0.5	1	2

Precision (Relative Standard Deviation)\*: ≤±12%

Linearity with No. of Pump Strokes: r<sup>2</sup> = 0.994

Humidity: No effect 0 - 90% RH

Temperature Range: 0 - 40°C (32 - 104°F)

Temp (°C/°F)	0/32	10/50	25/77	40/104
Corr. Factor	1.2	1.0	1.0	1.1

Storage Life: 2 years in darkness at 5 - 25°C (40 - 77°F). Refrigeration preferred.

Color Change: White → Brown

Reaction Principle: C<sub>8</sub>H<sub>10</sub> + I<sub>2</sub>O<sub>5</sub> + H<sub>2</sub>SO<sub>4</sub> → I<sub>2</sub> + Oxidation Products

<u>Cross-sensitivity:</u> Substance	Concentration (ppmv)	Apparent Reading*
Benzene	95	110 green-brown
p-Xylene	100	40
o-Xylene	100	35
m-Xylene	100	30
Ethylbenzene	100	70
Styrene	100	10
Ethylene	100	0
Isobutylene	100	0
Isobutylene	2000	100 (faint)
Hexane	100	7 (faint)
CO	3000	0
CO <sub>2</sub>	15000	0
H <sub>2</sub> S	50	55 (faint ring)
NH <sub>3</sub>	50000	0
CH <sub>4</sub>	25000	0
SO <sub>2</sub>	2050	0

\* Data based on Honeywell pumps and tubes used in standard range.

Other Possible Interferences: Other aromatics and reducing agents.

# Trichloroethylene $\text{CHCl}=\text{CCl}_2$ No. H-10-119-20

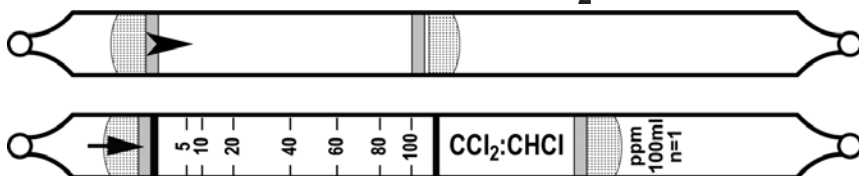

	Extended Range	Standard Range	Extended Range
Range (ppmv)	2.5 - 50	5 - 100	10 - 230
No. of Pump Strokes	2	1	0.5
Sample Volume (mL)	200	100	50
Sample Time (min)	2 x 3	3	2
Correction Factor	0.5	1	2.3

Precision (Relative Standard Deviation)\*:  $\pm 20\%$

Linearity with No. of Pump Strokes:  $r^2 = 0.999$

Humidity: No effect 0 - 95% RH

Temperature Range: 0 - 40°C (32 - 104°F)

Temp (°C/°F)	0/32	10/50	25/77	40/104
Corr. Factor	1.6	1.3	1.0	1.1

Storage Life: 1 year in darkness at 5 - 25°C (40 - 77°F). Refrigeration preferred.

Color Change: Yellow → Purple

Reaction Principle:  $\text{Cl}_2\text{C}=\text{CHCl} + \text{PbO}_2 + \text{H}_2\text{SO}_4 \rightarrow \text{HCl}$

$\text{HCl} + \text{Base} \rightarrow \text{Chloride (dye color change)}$

Cross-sensitivity: Substance	Concentration (ppmv)	Apparent Reading*
Tetrachloroethylene	40	70
1,2-Dichloroethylene	100	20
Vinyl Chloride	100	10
1,1,2-Trichloroethane	100	<0.5
Acetone	1000	0
Toluene	1000	0
p-Xylene	1000	0
$\text{Cl}_2$	10	10 (pale beige)
HCl	50	21
NO	500	0
$\text{NO}_2$	500	60 (pale beige)

\* Data based on Honeywell pumps and tubes used in standard range.

Other Possible Interferences: Acid gases. No response to  $\text{H}_2\text{S}$ , CO or  $\text{CH}_4$ .

Caution: Use of connector tubing other than that supplied may reduce response.

# Vinyl Chloride CH<sub>2</sub>=CHCl No. H-10-128-10

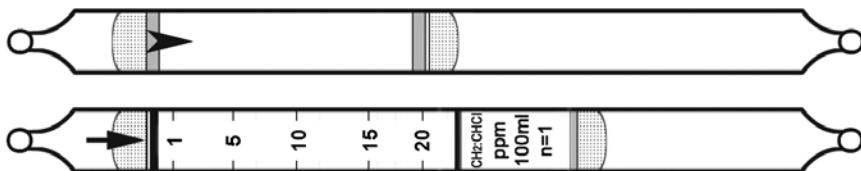

	Extended Range	Standard Range	Extended Range
Range (ppmv)	0.5-10	1-20	2-40
No. of Pump Strokes	2	1	0.5
Sample Volume (mL)	200	100	50
Sample Time (min)	2 x 3	3	3
Correction Factor	0.42	1.0	2.2

**Precision (Relative Standard Deviation)\*:** ≤±20%

**Linearity with No. of Pump Strokes:** r<sup>2</sup> = 0.991

**Humidity:** No effect 5 - 100% RH

**Temperature Range:** 0 - 40°C (32 - 104°F)

Temp (°C/°F)	0/32	10/50	25/77	40/104
Corr. Factor	2.5	1.3	1.0	0.8

**Storage Life:** 2 years in darkness at 5 - 25°C (40 - 77°F). Refrigeration preferred.

**Color Change:** Yellow → Purple

**Reaction Principle:** Pretube: C<sub>2</sub>H<sub>3</sub>Cl + K<sub>2</sub>Cr<sub>2</sub>O<sub>7</sub> + H<sub>2</sub>SO<sub>4</sub> → HCl + Other Prods

Measurement Tube: HCl + indicator dye → reddish purple color

Cross-sensitivity: Substance	Concentration (ppmv)	Apparent Reading*
1,3-Dichloropropylene	20	20
1,1-Dichloroethylene	10	16
Trichloroethylene	10	3.5
Tetrachloroethylene	60	1.5
Ethyl Chloroformate	40	0.4
Methyl Chloroformate	120	0.1
1,2-Dichloroethane	100	0
Methyl chloride	2000	0
Chloroform	100	0
Ethylene	1000	0
Benzene	600	0

\* Data based on Honeywell pumps and tubes used in standard range.

**Other Possible Interferences:** HCl, chlorinated hydrocarbons. No response to 500 ppm CO, 5000 ppm CO<sub>2</sub>, or 600 ppm toluene.

# Water Vapor (Pipeline) H<sub>2</sub>O No. H-10-120-10



	Extended Range	Standard Range	Extended Range
Range (lbs/MMCF)	1 - 5	2 - 10	4 - 20
No. of Pump Strokes	4	2	1
Sample Volume (mL)	400	200	100
Sample Time (min) in air	4 x 1.5 min	2 x 1.5 min	1.5 min
(sec) in natural gas	4 x 45 sec	2 x 45 sec	45 sec
Correction Factor	0.51	1	2.22

Precision (Relative Standard Deviation)\*:  $\leq \pm 12\%$

Linearity with No. of Pump Strokes:  $r^2 = 0.99$

Temperature Range: 0 - 40°C (32 - 104°F)

Temp (°C/°F)	0/32	10/50	23/73	40/104
Corr. Factor	1.1	1.0	1.0	0.9

Storage Life: 2 years in darkness at 5 - 25°C (40 - 77°F) Refrigeration preferred.

Color Change: Yellow → Green

Reaction Principle:  $\text{H}_2\text{O} + \text{Mg}(\text{ClO}_4)_2 \rightarrow \text{Mg}(\text{ClO}_4)_2 \cdot \text{H}_2\text{O}$

<u>Cross-sensitivity:</u> Substance	Concentration (ppmv)	Reading* (lbs/MMCF)
CH <sub>4</sub>	100%	0
Propane (C <sub>3</sub> H <sub>8</sub> )	10000	$\leq 2$
Isobutylene	10000	0
Hexanes	3000	0
CO	200	0
CO <sub>2</sub>	3000	0
SO <sub>2</sub>	1500	0
H <sub>2</sub> S	2000	~1
NH <sub>3</sub>	100	entire tube
HCl	300	0
Ethylene glycol	saturated	0
Triethylene glycol	saturated	0
Methanol	50	0‡
Toluene	400	~1

\* Data based on Honeywell pumps and tubes used in standard range.

‡ Forms light green stain when methanol is above 70 ppm. Water can be measured in a mixture with methanol by reading the dark green stain only, ignoring the light green methanol stain beyond dark green end point. See Technical Note on page 96 for pictures.

Other Possible Interferences: Amines, alcohols. No response to heptanes, octanes as present in "rich" natural gas or commonly called "condensate."



# Water Vapor (Pipeline) H<sub>2</sub>O No. H-10-120-20



	Extended Range	Standard Range	Extended Range
Range (lbs/MMCF)	3 - 20	6 - 40	12 - 80
No. of Pump Strokes	2	1	0.5
Sample Volume (mL)	200	100	50
Sample Time (min)	2 x 1.5	1.5	1
Correction Factor	0.45	1	2.3

**Precision (Relative Standard Deviation)\*:** ≤±20%

**Linearity with No. of Pump Strokes:** r<sup>2</sup> = 0.994

**Temperature Range:** 0 - 40°C (32 - 104°F)

Temp (°C/°F)	0/32	10/50	25/77	40/104
Corr. Factor	1.3	1.1	1.0	0.74

**Storage Life:** 2 years in darkness at 5 - 25°C (40 - 77°F) Refrigeration preferred

**Color Change:** Yellow → Dark Green\*\*

**Reaction Principle:** H<sub>2</sub>O + Mg(ClO<sub>4</sub>)<sub>2</sub> → Mg(ClO<sub>4</sub>)<sub>2</sub>•H<sub>2</sub>O

Cross-sensitivity: Substance	Concentration (ppmv)	Reading* (lbs/ MMCF)
CH <sub>4</sub>	100%	0
CO	200	0#
CO <sub>2</sub>	10%	0#
SO <sub>2</sub>	1500	0#
H <sub>2</sub> S	2000	<3#
NH <sub>3</sub>	250	35
HCl	300	0#
Methanol	80	0‡
Gasoline	saturated	0
Heptane	saturated	0
Ethylene glycol	saturated	0
Triethylene glycol	saturated	0
Toluene	saturated	0

\* Data based on Honeywell pumps and tubes used in standard range.

# No interference in mixtures with water vapor. ‡ No response below 80 ppm. Light green stain when methanol is above 80 ppm, 340 ppm alone reads ~30 lbs/MMCF. Water can be measured in a mixture with methanol by reading the dark green stain only, ignoring the light green methanol stain beyond the dark green end point.

\*\***Note:** Color tends towards purple as temperature decreases.

**Other Possible Interferences:** Amines, alcohols; no effect of 500 ppm PH<sub>3</sub>.

## Effect of Methanol & Glycols on Water Vapor Tubes

### Introduction

Colorimetric tubes for water vapor are commonly used to measure the humidity of natural gas because of their rapid response compared to instrumental methods. To minimize corrosion and to obtain a better selling price for the gas, water vapor levels are often reduced by passing the gas through a liquid scrubber containing ethylene glycol or triethylene glycol. In addition, methanol is sometimes added to the natural gas pipeline as an antifreeze so that ice does not accumulate during cold weather. This technical note describes how to read water vapor tubes that may have interference from these chemicals.

### Resistance to Glycol Response and “Rich” Gas

Newer versions of Honeywell water vapor tubes have been improved to remove any response to ethylene glycol or triethylene glycol. These changes were implemented in the 6-40 lbs/MMCF tubes (p/n H-10-120-20) shipped after November 2003 and in the 2-10 lbs/MMCF tubes (p/n H-10-120-10) shipped after November 2004. Higher alkanes such as pentane, hexanes and octanes present in “rich” natural gas also cause no response.

### Effect of Methanol

Methanol alone causes a light green response in both H-10-120-10 and H-10-120-20 tubes when its concentration is above about 80 ppm. When water and methanol are present together, a two-tone stain is seen. On the H-10-120-10 (2-10 lbs/MMCF) tubes, the water forms a medium-dark green stain followed by a light green stain for methanol (see Figure 1).

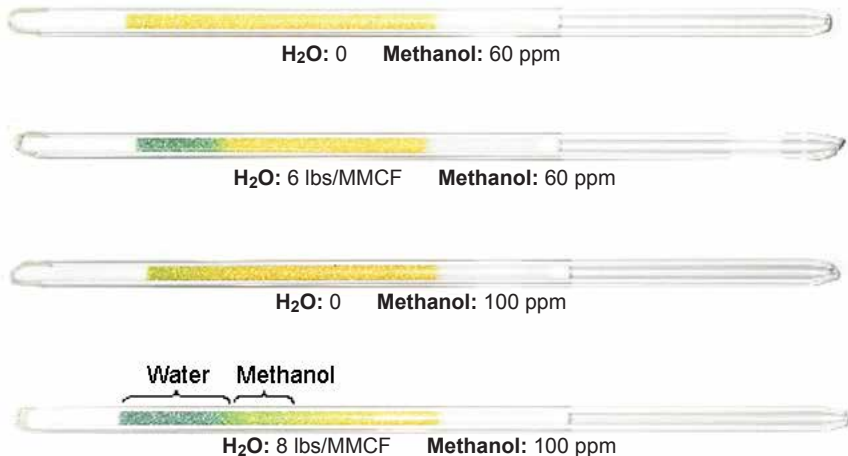
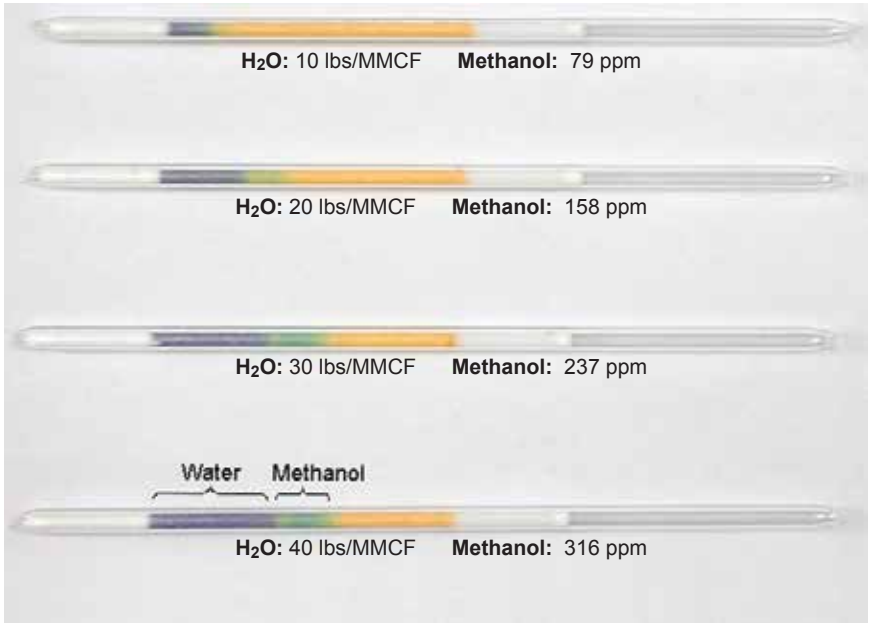
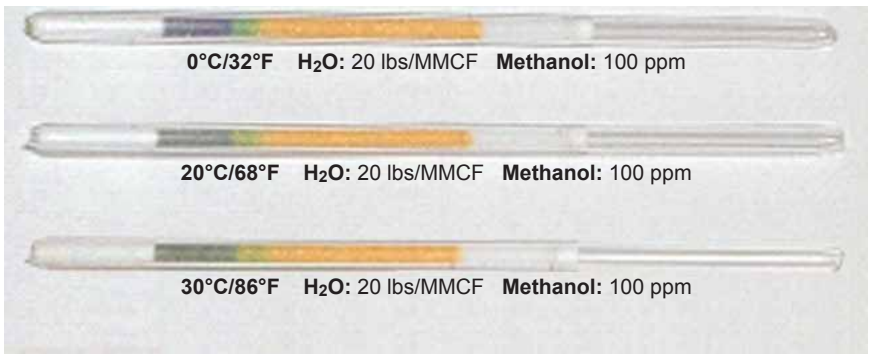

Figure 1. Methanol response on H-10-120-10 (2-10 lbs/MMCF) tube.

On the H-10-120-20 (6-40 lbs/MMCF) tubes, the water forms a purple stain followed by a light green stain for methanol (see Figure 2). This light green color can be ignored and only the darker stain read to obtain the water vapor concentration.



**Figure 2. Methanol response on H-10-120-20 (6-40 lbs/MMCF) tube.**



**Figure 3. Effect of Temperature on H-10-120-20 tube.**

Figure 3 shows that the color stain for water vapor is greener at higher temperatures and tends towards purple as the temperature is lowered. Therefore the distinction between methanol and water vapor response is clearer at lower temperatures.

# Water Vapor (Metric) H<sub>2</sub>O No. H-10-120-30

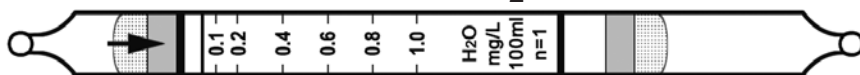

	Extended Range	Standard Range	Extended Range
Range (mg/L)	0.025 - 0.5	0.05 - 1.0	0.1 - 2.0
No. of Pump Strokes	2	1	0.5
Sample Volume (mL)	200	100	50
Sample Time (min)	2 x 1.5	1.5	1
Correction Factor	0.46	1	2.1

Precision (Relative Standard Deviation)\*:  $\leq \pm 12\%$

Linearity with No. of Pump Strokes:  $r^2 = 0.999$

Temperature Range: 0 - 40°C (32 - 104°F)

Temp (°C/°F)	0/32	10/50	25/77	40/104
Corr. Factor	0.95	0.95	1.0	1.0

Storage Life: 2 years in darkness at 5 - 25°C (40 - 77°F) Refrigeration preferred.

Color Change: Yellow → Dark Green\*\*

Reaction Principle:  $\text{H}_2\text{O} + \text{Mg}(\text{ClO}_4)_2 \rightarrow \text{Mg}(\text{ClO}_4)_2 \cdot \text{H}_2\text{O}$

Cross-sensitivity: Substance	Concentration (ppmv)	Reading* (mg/L)
CH <sub>4</sub>	100%	0
Propane (C <sub>3</sub> H <sub>8</sub> )	10000	0
CO	200	0#
CO <sub>2</sub>	10%	0#
SO <sub>2</sub>	1500	0#
H <sub>2</sub> S	600	0#
NH <sub>3</sub>	250	0.6
PH <sub>3</sub>	500	0
HCl	300	0#
Methanol	100	~0.02‡
Triethylene glycol	Saturated	~0.05
Toluene	400	<0.1

\* Data based on Honeywell pumps and tubes used in standard range.

# No interference in mixtures with water vapor.

‡ No response below 100 ppm. Positive interference when methanol is above 100 ppm. 250 ppm alone reads ~0.5 mg/L.

\*\* **Note:** Read tube at end of dark green stain. Color tends towards purple as temperature decreases.

Other Possible Interferences: Amines, alcohols.

# Water Vapor (Metric) H<sub>2</sub>O No. H-10-120-40



	Extended Range	Standard Range	Extended Range
Range (mg/L)	0.5 - 4	1 - 18	2 - 32
No. of Pump Strokes	2	1	0.5
Sample Volume (mL)	200	100	50
Sample Time (min)	2 x 1.5	1.5	1
Correction Factor	0.4	1	See Fig. 2

Precision (Relative Standard Deviation)\*:  $\leq \pm 20\%$

Linearity with No. of Pump Strokes:  $r^2 = 0.959$

Temperature Range: Refer to Figures 1 and 2. Requires accurate temperature measurement.

Storage Life: 1 year in darkness at 5 - 25°C (40 - 77°F). Refrigeration preferred.

Color Change: Yellow green → Purple

Reaction Principle:  $\text{H}_2\text{O} + \text{Mg}(\text{ClO}_4)_2 \rightarrow \text{Mg}(\text{ClO}_4)_2 \cdot \text{H}_2\text{O}$

<u>Cross-sensitivity:</u> Substance	Concentration (ppmv)	Reading* (mg/L)
CH <sub>4</sub>	25000	0
CO <sub>2</sub>	200000	0
CO	500	0
H <sub>2</sub> S	1000	0
SO <sub>2</sub>	3500	0
HCl	2000	0
NO <sub>2</sub>	460	0
NH <sub>3</sub>	460	1
PH <sub>3</sub>	40	0
Acetone	1000	1 (green)
Ethanol	2000	1.5

\* Data based on Honeywell pumps and tubes used in standard range.

**Continued on next page**

# Water Vapor H<sub>2</sub>O (Continued) No. H-10-120-40

Fig. 1. Temp. Correction, 1 Pump Stroke

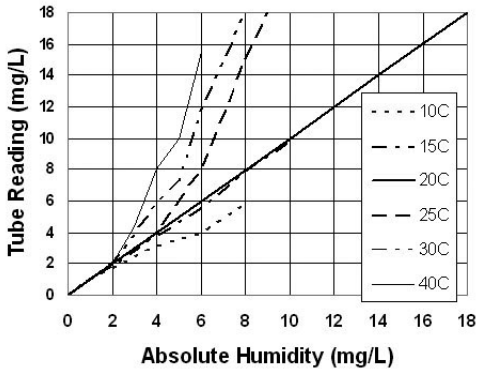
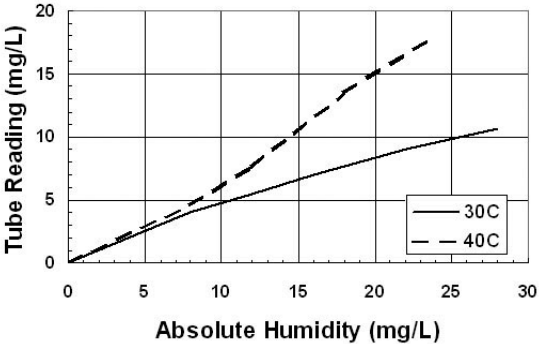
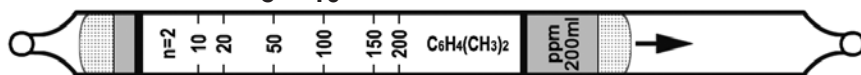

Fig. 2. Temp. Correction, 1/2 Stroke



DATA SHEETS

# Xylenes $C_8H_{10}$ No. H-10-112-20



	Extended Range	Standard Range	Extended Range
Range (ppmv)	5 - 100	10 - 200	20 - 400
No. of Pump Strokes	4	2	1
Sample Volume (mL)	400	200	100
Sample Time (min)	4 x 2	2 x 2	2
Correction Factor	0.5	1	2

**Precision (Relative Standard Deviation)\*:**  $\pm 12\%$

**Linearity with No. of Pump Strokes:**  $r^2 = 0.991$

**Humidity:** No effect 5 - 95% RH

**Temperature Range:** 0 - 40°C (32 - 104°F)

Temp (°C/°F)	0/32	10/50	21/70	40/104
Corr. Factor	2.4	1.4	1.0	1.7

**Storage Life:** 2 years in darkness at 5 - 25°C (40 - 77°F). Refrigeration preferred.

**Color Change:** White → Reddish Brown

**Reaction Principle:**  $C_8H_{10} + I_2O_5 + H_2SO_4 \rightarrow I_2 + \text{oxidation products}$

<u>Cross-sensitivity:</u> Substance	Concentration (ppmv)	Apparent Reading*
p-Xylene	100	100
o-Xylene	100	40 (brown)
m-Xylene	100	20 (brown)
Toluene	20	50 (brown)
Benzene	10	10 (v.faint)
Hexane	100	0
Isobutylene	100	0
CO	250	0
CO <sub>2</sub>	50000	0
H <sub>2</sub> S	5000	0
NO	100	3 (v.faint)
NH <sub>3</sub>	100	0
CH <sub>4</sub>	25000	0
SO <sub>2</sub>	10	0

\*Data based on Honeywell pumps and tubes used in standard range.

**Note:** The tube is calibrated to p-xylene.

**Other Possible Interferences:** Other aromatics.





## 6. SPECIALTY TUBES

### 6.1 Smoke Generating Tubes

Smoke generating tubes are designed for use in respirator fit tests. These tubes are of the stannic chloride type required by OSHA for use in the irritant smoke fit test procedure. The tubes can also be used for visualizing air currents, such as in testing the performance of fume hoods or in detecting leaks from an air duct.

#### 1. Operation

Smoke tubes are operated by simply breaking open each end and inserting into a rubber squeeze bulb or other pump. Air pushed through the tube releases the stannic chloride, which decomposes on contact with moisture in the air to form a smoke. The tubes can be re-used until no more smoke is evolved. Rubber caps are provided to seal the tubes between uses.

#### 2. Smoke Tube Kit

The Smoke Tube Kit (Part no. H-010-0004-000) contains the following:

- Aspirator bulb
- Tube tip breaker
- 1 Box of 6 smoke tubes
- Soft carrying case



**Figure 6.1. Use of smoke tube for visualizing fume hood air currents.**

# Gas Generation Tube Data Sheet

## Irritant Smoke

No. H-10-123-01

Color: A white smoke is generated. The tube changes from a dark reddish brown to a lighter reddish brown. The tube can be used repeatedly until it is spent. Keep the tube closed between uses with the supplied rubber caps.

Reagent Type: Stannic chloride

Reaction Principle:  $\text{SnCl}_4 + \text{H}_2\text{O} \rightarrow \text{stannic oxychlorides} + 2\text{HCl}$

Humidity Range: 10 - 95% RH. The smoke generating life increases about 10% at 20% RH and decreases about 10% at 80% RH (incoming air humidity).

Temperature Range: 0 - 40°C (32 - 104°F). As temperature decreases the smoke lasts longer and is less intense.

Storage Life and Conditions: 2 years in darkness at 5 - 25°C (40 - 77°F)

### **CAUTIONS ON USE:**

- Read, understand and comply with all labels, warnings and instructions accompanying these tubes before use. Failure to comply may cause serious injury or death.
- For use in respirator fit testing according to OSHA 29 CFR 1910.134 (appendix A) and OSHA 1910.139.
- Wear safety glasses and gloves to protect against chemical exposure and flying glass. Wear a respirator when exposed to smoke. Vapors are corrosive to skin and overexposure can result in serious injury or death.
- DO NOT inhale smoke directly. If inhaled enough to cause coughing, remove victim to fresh air. If coughing persists, provide oxygen and contact a physician.
- Use only in a well-ventilated area. DO NOT use in a confined space.
- DO NOT use under a respirator fit testing hood or other enclosed space because fume concentrations may build up to levels that can cause serious injury or death.
- Avoid contact of smoke with skin. DO NOT direct smoke stream directly at the skin during fit testing. If smoke contacts skin for prolonged time, skin burns can result; flush with copious amounts of water for 15 minutes and contact a physician.
- If smoke contacts eyes, immediately flush with water for 15 minutes and contact a physician. Eyes should be kept tightly closed during fit testing.
- Use only the pump(s) and flow rates specified in OSHA CFR 1910.134 and 29 CFR 1910.139. If the pump is operated at non-specified flow rates it could increase the smoke and fume concentrations and cause serious injury or death.
- Do not use smoke tubes in areas that may contact food or food eating areas. Ingestion of tube contents or food exposed to smoke may cause serious injury or death.
- Do not use for fit testing on persons with pre-existing respiratory or related medical conditions or are allergic to tin compounds or hydrochloric acid.
- When using for visualizing air currents, avoid exposure to persons downstream of the air flow.

Disposal: Dispose of spent or expired tubes according to local regulations. Each tube contains 1.0 g of stannic chloride before use. Tube contents generate hydrochloric acid on contact with water.

## 7 APPENDICES

### 7.1 Appendix 1. Alphabetical Tube List

Compound	Tube Number	Standard Range (ppmv unless noted)	Total Meas. Range (ppmv unless noted)	Standard Meas. Time (Strokes x min. per stroke)
Acetone	H-10-111-40	0.1 - 2%	0.05 - 4%	1 x 2
Amines	H-10-132-10	0.5 - 10	0.25 - 20	1 x 1
Ammonia	H-10-100-05	1 - 30	0.5 - 60	1 x 1.5
	H-10-100-10	5 - 100	2.5 - 200	1 x 1
	H-10-100-12	10 - 260	5 - 520	1 x 1.5
	H-10-100-15	25 - 500	12 - 1000	1 x 1
	H-10-100-40	1 - 15%	0.5 - 30%	1 x 2
Benzene	H-10-101-01	0.5 - 10	0.25 - 30	3 x 3
	H-10-101-10	5 - 40	2.5 - 200	5 x 3
	H-10-101-20	5 - 100	2.5 - 200	1 x 2
1,3-Butadiene	H-10-135-04	0.5 - 5	0.25 - 10	2 x 2
n-Butane	H-10-137-30	25 - 1400	12.5 - 2800	1 x 2.5
Carbon Dioxide	H-10-104-30	300 - 5000	150 - 10000	1 x 2
	H-10-104-40	0.05 - 1%	0.025 - 2%	1 x 2
	H-10-104-45	0.25 - 3%	0.125 - 6%	1 x 2
	H-10-104-50	1 - 20%	0.25 - 20%	0.5 x 1
	H-10-104-60	5 - 40%	1.25 - 40%	0.5 x 1
Carbon Monoxide	H-10-102-18	5 - 100	2.5 - 300	3 x 3
	H-10-102-20	5 - 100	2.5 - 200	1 x 2
	H-10-102-30	20 - 500	10 - 1000	1 x 1.5
	H-10-102-45	0.2 - 4%	0.1 - 8%	0.5 x 1
Chlorine	H-10-106-10	0.5 - 8	0.25 - 16	1 x 2.5
	H-10-106-20	5 - 100	2.5 - 200	1 x 2
Chlorine Dioxide	H-10-130-10	0.25 - 15	0.05 - 30	1 x 2
Diesel & Jet Fuel	H-10-143-10	0.25 - 25	N/A	4 x 1.5
Ethanol	H-10-141-30	100 - 2000	50 - 2000	1 x 3
Formaldehyde	H-10-121-05	0.1 - 5	0.1 - 40	5 x 2
Gasoline	H-10-138-30	30 - 1000	15 - 2000	2 x 2
Hydrocarbons	H-10-110-30	50 - 1000	25 - 2000	2 x 2
Hydrogen Chloride	H-10-108-09	1 - 20	0.5 - 40	1 x 1
	H-10-108-10	1 - 20	0.5 - 40	1 x 1
	H-10-108-22	20 - 500	10 - 1000	1 x 1.5
Hydrogen Cyanide	H-10-126-10	2.5 - 60	1.25 - 120	2 x 2.5
Hydrogen Fluoride	H-10-105-10	0.5 - 20	0.25 - 40	4 x 0.5
Hydrogen Sulfide	H-10-103-04	0.2 - 3	0.1 - 6	1 x 1.5
	H-10-103-05	0.2 - 3	0.1 - 6	1 x 2

## Appendix 1 (Continued). Alphabetical Tube List

Compound	Tube Number	Standard Range (ppmv unless noted)	Total Meas. Range (ppmv unless noted)	Standard Meas. Time (Strokes x min. per stroke)
Hydrogen Sulfide (cont.)	H-10-103-06	1 - 7	0.25 - 7	0.5 x 1
	H-10-103-10	2.5 - 60	1.25 - 120	1 x 1.5
	H-10-103-12	0 - 150	0 - 300	1 x 1.5
	H-10-103-15	10 - 120	5 - 240	1 x 1.5
	H-10-103-18	25 - 250	12.5 - 500	1 x 1
	H-10-103-20	50 - 800	25 - 1600	1 x 2
	H-10-103-30	100 - 2000	50 - 4000	1 x 2
	H-10-103-40	0.1 - 2%	0.05 - 4%	1 x 2
	H-10-103-50	2 - 40%	0.5 - 40%	0.5 x 2
Mercaptans	H-10-129-20	5 - 120	2.5 - 240	1 x 2
Methyl Bromide	H-10-131-10	1 - 18	0.5 - 36	2 x 3
	H-10-131-30	20 - 300	10 - 600	1 x 2
Methyl Ethyl Ketone	H-10-113-20	0.02 - 0.6%	0.01 - 1.8%	3 x 2
Nitric Acid	H-10-146-20	1 - 20	0.5 - 40	1 x 1
Nitrogen Dioxide	H-10-117-10	0.5 - 30	N/A	1 x 1.5
Nitrogen Oxides	H-10-109-20	1 - 50	0.5 - 100	1 x 3
Ozone	H-10-133-03	0.05 - 0.6	0.05 - 1.8	5 x 2
Phenol	H-10-139-05	1 - 25	0.5 - 180	2 x 1.5
Phosphine	H-10-116-10	5 - 50	2.5 - 100	2 x 1.5
	H-10-116-20	25 - 500	12.5 - 1000	1 x 1.5
	H-10-116-25	50 - 1000	25 - 2000	1 x 1.5
Sulfur Dioxide	H-10-107-15	2 - 30	1 - 60	2 x 2
	H-10-107-20	5 - 100	2.5 - 200	1 x 2
	H-10-107-25	100 - 1800	50 - 3600	1 x 2
	H-10-107-30	200 - 4000	50 - 4000	0.5 x 1
	H-10-107-40	0.2 - 5%	0.1 - 10%	1 x 2
Toluene	H-10-114-20	10 - 300	5 - 600	1 x 2
Trichloroethylene	H-10-119-20	5 - 100	2.5 - 230	1 x 3
Vinyl Chloride	H-10-128-10	1 - 20	0.5 - 40	1 x 3
Water Vapor	H-10-120-10	2-10 lbs/MMCF	1-20 lbs/MMCF	2 x 1.5
	H-10-120-20	6-40 lbs/MMCF	3-80 lbs/MMCF	1 x 1.5
	H-10-120-30	0.05 - 1 mg/L	0.025 - 2 mg/L	1 x 1.5
	H-10-120-40	1 - 18 mg/L	0.5 - 32 mg/L	1 x 1.5
Xylenes	H-10-112-20	10 - 200	5 - 400	2 x 2

## 7.2 Appendix 2. Tube List by Part Number

Tube Number	Compound	Standard Range (ppmv unless noted)	Total Measurement Range (ppmv unless noted)
H-10-100-05	Ammonia	1 - 30	0.5 - 60
H-10-100-10		5 - 100	2.5 - 200
H-10-100-12		10 - 260	5 - 520
H-10-100-15		25 - 500	12 - 1000
H-10-100-40		1 - 15%	0.5 - 30%
H-10-101-01	Benzene	0.5 - 10	0.25 - 30
H-10-101-10		5 - 40	2.5 - 200
H-10-101-20		5 - 100	2.5 - 200
H-10-102-18	Carbon Monoxide	5 - 100	2.5 - 300
H-10-102-20		5 - 100	2.5 - 200
H-10-102-30		20 - 500	10 - 1000
H-10-102-45		0.2 - 4%	0.1 - 8%
H-10-103-04	Hydrogen Sulfide	0.2 - 3	0.1 - 6
H-10-103-05		0.2 - 3	0.1 - 6
H-10-103-06		1 - 7	0.25 - 7
H-10-103-10		2.5 - 60	1.25 - 120
H-10-103-12		0 - 150	0 - 300
H-10-103-15		10 - 120	5 - 240
H-10-103-18		25 - 250	12.5 - 500
H-10-103-20		50 - 800	25 - 1600
H-10-103-30		100 - 2000	50 - 4000
H-10-103-40		0.1 - 2%	0.05 - 4%
H-10-103-50		2 - 40%	0.5 - 40%
H-10-104-30	Carbon Dioxide	300 - 5000	150 - 10000
H-10-104-40		0.05 - 1%	0.025 - 2%
H-10-104-45		0.25 - 3%	0.125 - 6%
H-10-104-50		1 - 20%	0.25 - 20%
H-10-104-60		5 - 40%	1.25 - 40%
H-10-105-10	Hydrogen Fluoride	0.5 - 20	0.25 - 40
H-10-106-10	Chlorine	0.5 - 8	0.25 - 16
H-10-106-20		5 - 100	2.5 - 200
H-10-107-15	Sulfur Dioxide	2 - 30	1 - 60
H-10-107-20		5 - 100	2.5 - 200
H-10-107-25		100 - 1800	50 - 3600
H-10-107-30		200 - 4000	50 - 4000
H-10-107-40		0.2 - 5%	0.1 - 10%
H-10-108-09	Hydrogen Chloride	1 - 20	0.5 - 40
H-10-108-10		1 - 20	0.5 - 40
H-10-108-22		20 - 500	10 - 1000
H-10-109-20	Nitrogen Oxides	1 - 50	0.5 - 100
H-10-110-30	Hydrocarbons	50 - 1000	25 - 2000
H-10-111-40	Acetone	0.1 - 2%	0.05 - 4%
H-10-112-20	Xylenes	10 - 200	5 - 400

## Appendix 2 (Continued). Tube List by Part Number

Tube Number	Compound	Standard Range (ppmv unless noted)	Total Measurement Range (ppmv unless noted)
H-10-113-20	Methyl Ethyl Ketone	0.02 - 0.6%	0.01 - 1.8%
H-10-114-20	Toluene	10 - 300	5 - 600
H-10-116-10	Phosphine	5 - 50	2.5 - 100
H-10-116-20		25 - 500	12.5 - 1000
H-10-116-25		50 - 1000	25 - 2000
H-10-117-10	Nitrogen Dioxide	0.5 - 30	N/A
H-10-119-20	Trichloroethylene	5 - 100	2.5 - 230
H-10-120-10	Water Vapor	2-10 lbs/MMCF	1-20 lbs/MMCF
H-10-120-20		6-40 lbs/MMCF	3-80 lbs/MMCF
H-10-120-30		0.05 - 1 mg/L	0.025 - 2 mg/L
H-10-120-40		1 - 18 mg/L	0.5 - 32 mg/L
H-10-121-05	Formaldehyde	0.1 - 5	0.1 - 40
H-10-126-10	Hydrogen Cyanide	2.5 - 60	1.25 - 120
H-10-128-10	Vinyl Chloride	1 - 20	0.5 - 40
H-10-129-20	Mercaptans	5 - 120	2.5 - 240
H-10-130-10	Chlorine Dioxide	0.25 - 15	0.05 - 30
H-10-131-10	Methyl Bromide	1 - 18	0.5 - 36
H-10-131-30		20- 300	10 - 600
H-10-132-10	Amines	0.5 - 10	0.25 - 20
H-10-133-03	Ozone	0.05 - 0.6	0.05 - 1.8
H-10-135-04	1,3-Butadiene	0.5 - 5	0.25 - 10
H-10-137-30	n-Butane	25 - 1400	12.5 - 2800
H-10-138-30	Gasoline	30 - 1000	15 - 2000
H-10-139-05	Phenol	1 - 25	0.5 - 180
H-10-141-30	Ethanol	100 - 2000	50 - 2000
H-10-143-10	Diesel & Jet Fuel	0.25 - 25	N/A
H-10-146-20	Nitric Acid	1 - 20	0.5 - 40

## 7.3 Appendix 3. Detectable Compounds

Compound to be Measured	Tube Used	Tube Number	Standard Range (ppmv unless noted)	
Acetaldehyde	Formaldehyde	H-10-121-05	0.1 - 5	
Acetone	Acetone	H-10-111-40	0.1- 2%	
	Methyl Ethyl Ketone	H-10-113-20		
Ammonia	Ammonia	H-10-100-05	1 - 30	
		H-10-100-10	5 - 100	
		H-10-100-12	10 - 260	
		H-10-100-15	25 - 500	
		H-10-100-40	1 - 15%	
	Amines	H-10-132-10		
	Hydrogen Sulfide	H-10-103-50		
	Sulfur Dioxide	H-10-107-40		
Allylamine	Amines	H-10-132-10		
Benzene	Benzene	H-10-101-01	0.5 - 10	
		H-10-101-10	5 - 40	
		H-10-101-20	5 - 100	
	Toluene	H-10-114-20		
	Gasoline	H-10-138-30		
1,3-Butadiene	1,3-Butadiene	H-10-135-04	0.5 - 5	
n-Butane	n-Butane	H-10-137-30	25 - 1400	
	Hydrocarbons	H-10-110-30		
t-Butanol	Ethanol	H-10-141-30		
2-Butanone	Methyl Ethyl Ketone	H-10-113-20	0.02 - 0.6%	
Butylamine	Ammonia	H-10-100-05		
		H-10-100-10		
		H-10-100-12		
		H-10-100-15		
Butyl Mercaptan	Mercaptans	H-10-129-20		
	Hydrogen Sulfide	H-10-103-04		
		H-10-103-06		
Carbon Dioxide	Carbon Dioxide	H-10-104-30	300 - 5000	
		H-10-104-40	0.05 - 1%	
		H-10-104-45	0.25 - 3%	
		H-10-104-50	1 - 20%	
		H-10-104-60	5 - 40%	
Carbon Monoxide	Carbon Monoxide	H-10-102-18	5 - 100	
		H-10-102-20	5 - 100	
		H-10-102-30	20 - 500	
		H-10-102-45	0.2 - 4%	
		Benzene	H-10-101-10	
			H-10-101-20	
		Diesel & Jet Fuel	H-10-143-10	

## Appendix 3 (Continued). Detectable Compounds

Compound to be Measured	Tube Used	Tube Number	Standard Range (ppmv unless noted)
Chloride	Methyl Bromide	H-10-131-30	20- 300
Chlorine	Chlorine	H-10-106-10	0.5 - 8
		H-10-106-20	5 - 100
	Chlorine Dioxide	H-10-130-10	
	Methyl Bromide	H-10-131-10	
Chlorine Dioxide	Chlorine Dioxide	H-10-130-10	0.25 - 15
	Chlorine	H-10-106-10	
		H-10-106-20	
n-Decane	Hydrocarbons	H-10-110-30	
1,2-Dibromoethane	Methyl Bromide	H-10-131-30	20- 300
1,3-Dibromopropane	Methyl Bromide	H-10-131-30	20- 300
Diesel Fuel	Diesel & Jet Fuel	H-10-143-10	0.5 - 25
Diethylamine	Amines	H-10-132-10	0.5 - 10
	Ammonia	H-10-100-05	
		H-10-100-10	
		H-10-100-12	
		H-10-100-15	
1,1-Dichloroethylene	Vinyl Chloride	H-10-128-10	
	Methyl Bromide	H-10-131-10	
1,2- Dichloroethylene	Trichloroethylene	H-10-119-20	
1,3-Dichloropropylene	Vinyl Chloride	H-10-128-10	1 - 20
Ethanol	Ethanol	H-10-141-30	100 - 2000
Ethanolamine	Amines	H-10-132-10	
Ethylamine	Amines	H-10-132-10	0.5 - 10
Ethylbenzene	Toluene	H-10-114-20	
Ethylene	Hydrocarbons	H-10-110-30	
Ethylenediamine	Amines	H-10-132-10	
Ethyl Mercaptan	Mercaptans	H-10-129-20	5 - 120
Formaldehyde	Formaldehyde	H-10-121-05	0.1 - 5
Gasoline	Gasoline	H-10-138-30	30 - 1000
	Diesel & Jet Fuel	H-10-143-10	
n-Heptane	Hydrocarbons	H-10-110-30	
n-Hexane	Hydrocarbons	H-10-110-30	
	Butane	H-10-137-30	
	Carbon Monoxide	H-10-102-30	
Hydrocarbons	Hydrocarbons	H-10-110-30	50 - 1000
Hydrogen Chloride	Hydrogen Chloride	H-10-108-09	1 - 20
		H-10-108-10	1 - 20
		H-10-108-22	20 - 500
	Nitric Acid	H-10-146-20	1 - 20
Hydrogen Cyanide	Hydrogen Cyanide	H-10-126-10	2.5 - 60



## Appendix 3 (Continued). Detectable Compounds

Compound to be Measured	Tube Used	Tube Number	Standard Range (ppmv unless noted)	
Hydrogen Fluoride	Hydrogen Fluoride	H-10-105-10	0.5 - 20	
	Hydrogen Chloride	H-10-108-09		
	Nitric Acid	H-10-146-20	1 - 20	
Hydrogen Sulfide	Hydrogen Sulfide	H-10-103-04	0.2 - 3	
		H-10-103-05	0.2 - 3	
		H-10-103-06	1 - 7	
		H-10-103-10	2.5 - 60	
		H-10-103-12	0 - 150	
		H-10-103-15	10 - 120	
		H-10-103-18	25 - 250	
		H-10-103-20	50 - 800	
		H-10-103-30	100 - 2000	
		H-10-103-40	0.1 - 2%	
		H-10-103-50	2 - 40%	
		Benzene	H-10-101-20	
		Gasoline	H-10-138-30	
	Hydrocarbons	H-10-110-30		
	Phosphine	H-10-116-10		
		H-10-116-20		
		H-10-116-25		
Isobutane	Hydrocarbons	H-10-110-30	50 - 1000	
	Butane	H-10-137-30		
Isobutylene	Methyl Ethyl Ketone	H-10-113-20		
	1,3-Butadiene	H-10-135-04	0.5 - 5	
Isopar L	Gasoline	H-10-138-30		
Isopropanol	Ethanol	H-10-141-30		
Jet Fuel JP-5, JP-8	Diesel & Jet Fuel	H-10-143-10	0.5 - 25	
Methanol	Ethanol	H-10-141-30	100 - 2000	
Methylamine	Amines	H-10-132-10	0.5 - 10	
Methyl Bromide	Methyl Bromide	H-10-131-10	1 - 18	
		H-10-131-30	20 - 300	
Methyl Ethyl Ketone (MEK)	Methyl Ethyl Ketone	H-10-113-20	0.02 - 0.6%	
	Acetone	H-10-111-40		
Methyl Isobutyl Ketone	Methyl Ethyl Ketone	H-10-113-20		
	Acetone	H-10-111-40		
Methyl Mercaptan	Mercaptans	H-10-129-20	5 - 120	
	Ethanol	H-10-141-30		
	Hydrogen Sulfide	H-10-103-04		
	Hydrogen Sulfide	H-10-103-06		
	Hydrogen Sulfide	H-10-103-40		
Methyl Propyl Ketone	Methyl Ethyl Ketone	H-10-113-20		
	Acetone	H-10-111-40		

## Appendix 3 (Continued). Detectable Compounds

Compound to be Measured	Tube Used	Tube Number	Standard Range (ppmv unless noted)
Nitric Acid	Nitric Acid	H-10-146-20	1 - 20
Nitric Oxide	Nitrogen Oxides	H-10-109-20	
	Benzene	H-10-101-20	
	Carbon Monoxide	H-10-102-20	
	Carbon Monoxide	H-10-102-30	
	Ethanol	H-10-141-30	
Nitrogen Dioxide	Nitrogen Dioxide	H-10-117-10	0.5 - 30
	Nitrogen Oxides	H-10-109-20	1 - 50
	Chlorine	H-10-106-10	
		H-10-106-20	
	Chlorine Dioxide	H-10-130-10	
Nitrogen Oxides	Nitrogen Oxides	H-10-109-20	1 - 50
n-Octane	Diesel & Jet Fuel	H-10-143-10	
	Hydrocarbons	H-10-110-30	
Ozone	Ozone	H-10-133-03	0.05 - 0.6
n-Pentane	Hydrocarbons	H-10-110-30	
	Butane	H-10-137-30	
Perchloroethylene	Trichloroethylene	H-10-119-20	
Petroleum Naphtha	Hydrocarbons	H-10-110-30	
Phenol	Phenol	H-10-139-05	1 - 25
Phosphine	Phosphine	H-10-116-10	5 - 50
		H-10-116-20	25 - 500
		H-10-116-25	50 - 1000
Propionaldehyde	Formaldehyde	H-10-121-05	0.1 - 5
Propane	Butane	H-10-137-30	
Propyleneimine	Amines	H-10-132-10	
Propyl Mercaptan	Mercaptans	H-10-129-20	5 - 120
Sulfur Dioxide	Sulfur Dioxide	H-10-107-15	2 - 30
		H-10-107-20	5 - 100
		H-10-107-25	100 - 1800
		H-10-107-30	200 - 4000
		H-10-107-40	0.2 - 5%
	Carbon Dioxide	H-10-104-30	
		H-10-104-45	
	Hydrogen Cyanide	H-10-126-10	
Styrene	Toluene	H-10-114-20	
Tetrachloroethylene	Trichloroethylene	H-10-119-20	
Toluene	Toluene	H-10-114-20	10 - 300
	Benzene	H-10-101-20	
	Gasoline	H-10-138-30	
	Hydrocarbons	H-10-110-30	
	Xylenes	H-10-112-20	

## Appendix 3 (Continued). Detectable Compounds

Compound to be Measured	Tube Used	Tube Number	Standard Range (ppmv unless noted)
1,1,1-Trichloroethane	Methyl Bromide	H-10-131-10	
Trichloroethylene	Trichloroethylene	H-10-119-20	5 - 100
	Carbon Monoxide	H-10-102-20	
	Carbon Monoxide	H-10-102-30	
	Vinyl Chloride	H-10-128-10	
Trimethylamine	Amines	H-10-132-10	
Undecane	Diesel & Jet Fuel	H-10-143-10	0.5 - 25
Water Vapor	Water Vapor	H-10-120-10	2 - 10 lbs/MMCF
		H-10-120-20	6 - 40 lbs/MMCF
		H-10-120-30	0.05 - 1 mg/L
		H-10-120-40	1 - 18 mg/L
m-Xylene	Xylenes	H-10-112-20	
	Toluene	H-10-114-20	
o-Xylene	Xylenes	H-10-112-20	
	Toluene	H-10-114-20	
p-Xylene	Xylenes	H-10-112-20	10 - 200
	Toluene	H-10-114-20	

## 7.4 Appendix 4. Equivalent Tubes of Other Manufacturers

Compound	Honeywell		Gastec		Kitagawa		Draeger		MSA-AUER		
	Tube #	Range*	Tube #	Range*	Tube #	Range*	Tube #	Range*	MSA #	AUER #	Range*
Acetone	H-10-111-40	0.1-2%	151	0.01-0.8%	102SC	0.01-4%			804141	5086-829	0.01-1%
Amines	H-10-132-10	0.5-10	180L	0.5-10	227S	1-20	6733231	2-30			
Ammonia	H-10-100-10	1-30	3L	1-30	105SD	1-20	6733231	2-30	804134	5086-816	4-55
	H-10-100-10	5-100	3La	5-100	105SC	5-130	8101941	5-100	804405	5085-845	10-500
	H-10-100-12	10-260			105SC	10-260					
	H-10-100-15	25-500	3M	25-500	105SB	50-900			800300	5085-814	20-1000
	H-10-100-40	1-15%	3H	1-15%	105SA	0.5-10%	CH31901	0.5-10%	804406	5085-815	0.5-10%
Benzene	H-10-101-01	0.5-10	121SP	0.5-10			8101841	0.5-10	807024	5086-835	1-25
	H-10-101-10	5-40	121SL	1-20	118SB	5-200	8101231	2-60			
	H-10-101-20	5-100	121	5-60	118SC	4-100	6728071	5-50	804411	5085-816	5-100
1,3-Butadiene	H-10-135-04	0.5 - 5	174LL	0.5-5	168SE	0.1-2					
n-Butane	H-10-137-30	25-1400	104	25-1400	221SA	500-6000					
2-Butanone (MEK)	H-10-113-20	0.02-0.6%	152	0.02-0.6%	139SB	0.01-1.4%			813334	5086-837	0.005-0.4%
Carbon Dioxide	H-10-104-30	300-5,000	2LL	300-5000	126SC	300-7000	8101811	100-3000	497606	5086-814	100-3000
	H-10-104-40	0.05-1%			126SB	0.05-1.0%					
	H-10-104-45	0.25-3%	2L	0.25-3%	126SA	0.1 - 2.6%	CH23501	0.5-6%	487333	5085-817	0.5-7%
	H-10-104-50	1-20%	2H	1-10%	126SH	1-20%	CH25101	1-20%	804419	5085-841	1-20%
	H-10-104-60	5-40%	2HH	5-40%	126UH	5-50%	CH20301	5-60%			
Carbon Monoxide	H-10-102-18	5-100	1LK	5-100			CH19701	8-150			
	H-10-102-20	5-100	1LL	5-50	106SB	5-50	6728511	5-150			
	H-10-102-30	20-500	1La	25-500	106S	10-250			803943	5085-836	50-1000
	H-10-102-45	0.2-4%	1H	0.2-5%	106SH	0.1-2.0%			804423	5085-822	0.1-1.0%
Chlorine	H-10-106-10	0.5-8	8La	0.5-8	109SB	0.5-10	6728411	0.3-5	803944	5085-801	2-30
	H-10-106-20	5-100	8H	50-500	178S	50-140	CH20701	50-500			
Chlorine Dioxide	H-10-130-10	0.25-15			116	1-20			804133	5086-812	0.25-15

\* Units are ppmv unless noted.

# Appendix 4 (Continued). Equivalent Tubes of Other Manufacturers

Compound	Honeywell		Gastec		Kitagawa		Draeger		MSA-AUER		
	Tube #	Range*	Tube #	Range*	Tube #	Range*	Tube #	Range*	MSA #	AUER #	Range *
Diesel & Jet Fuel	H-10-143-10	0.5-25									
Ethanol	H-10-141-30	100-2000	112L	100-2000	119U	20-1000	CH29701	100-3000	804136	5086-818	100-3000
Formaldehyde	H-10-121-05	0.1-5	91L	0.1-5	171SC	0.1-4	6733081	0.5-5	497649	5086-813	1-10
Gasoline	H-10-138-30	30-1000	101L	30-1000	110S	500-6000			492870	5085-898	30-600
Hydrocarbons	H-10-110-30	50-1,000	105	200-3000	187S	50-1400					
Hydrogen Chloride	H-10-108-09	1-20									
	H-10-108-10	1-20	14L	1-20	173SB	2-20	CH29501	1-10	803948	5085-846	1-30
	H-10-108-22	20-500	14M	20-500	173SA	20-600	6728181	50-500			
Hydrogen Cyanide	H-10-126-10	2.5-60	12L	2.5-60	112B	2-100	CH25701	2-30	803945	5085-824	5-50
Hydrogen Fluoride	H-10-105-10	0.5-20	17	0.5-20	156S	1-30	CH30301	1.5-15	804142	5086-830	5-50
Hydrogen Sulfide	H-10-103-04	0.2-3	4LT	0.2-2	120UP	0.2-3	8101991	0.2-6			
	H-10-103-05	0.2-3	4LT	0.2-2	120U	0.2-3	8101991	0.2-6			
	H-10-103-06	1-7					8101991	0.2-6			
	H-10-103-10	2.5-60	4LL	2.5-60	120SD	5-60	CH29801	2-60			
	H-10-103-12	0 - 150	4L	10-120	120SB	10-200	6719001	3-150	487339	5085-826	10-200
	H-10-103-15	10-120	4L	10-120	120SB	10-200	6719001	3-150	487339	5085-826	10-200
	H-10-103-18	25-250	4M	25-250			6728821	20-200	487339	5085-826	10-200
	H-10-103-20	50-800	4HM	50-800	120SC	5-1600					
	H-10-103-30	100-2000	4H	100-2000	120SA	100-2000	CH29101	100-2000	487340	5085-827	100-4000
	H-10-103-40	0.1-2%	4HH	0.1-2%	120SH	0.2-7%	CH28101	0.1-4.0%			
	H-10-103-50	2-40%	4HT	2-20%	120UH	2-40%	8101211	2-20%			
Mercaptans	H-10-129-20	5-120	70	5-120	164SA	5-140	8101871	20-100	804589	5086-815	10-80
Methyl Bromide	H-10-131-10	1-18	136LA	1-18	157SC	1-10	8101671	0.5-5			
	H-10-131-30	20-300	136H	20-300	157SA	10-500	CH27301	5-50	710391	5086-845	2-100
Nitric Acid	H-10-146-20	1- 20	15L	1- 20	233S	2-20	6728311	1-50			

\* Units are ppmv unless noted.

## Appendix 4 (Continued). Equivalent Tubes of Other Manufacturers

Compound	Honeywell		Gastec		Kitagawa		Draeger		MSA-AUER		
	Tube #	Range*	Tube #	Range*	Tube #	Range*	Tube #	Range*	MSA #	AUER #	Range*
Nitrogen Dioxide	H-10-117-10	0.5-30	9L	0.5-30	117SB	0.5-30	CH30001	0.5-10	487341	5085-805	0.5-50
Nitrogen Oxides	H-10-109-20	Jan-50	10	5-200	175U	Feb-50	CH31001	1.0-50	487341	5085-805	0.5-50
Ozone	H-10-133-03	0.05-0.6	18L	0.05-0.6	182U	0.05-1	6733181	0.05-0.7	804140	5086-828	0.05-1
Phenol	H-10-139-05	1-25	60	1-25	183U	0.5-25	8101641	1-20	813778	5086-838	1-25
Phosphine	H-10-116-10	5-50	7	5-50	121SB	10-100	8101801	5-90	485680	5085-830	0.1-10
	H-10-116-20	25-500	7J	25-500	121SC	20-700					
	H-10-116-25	50-1000			121SC	40-1400	CH21201	50-1000	489119	5085-831	50-2000
Sulfur Dioxide	H-10-107-15	2-30	5La	2-30	103SD	1-25	6728491	1-60	487338	5085-803	1-25
	H-10-107-20	5-100	5L	5-100	103SC	20-200	CH24201	20-300	497662	5085-813	5-120
	H-10-107-25	100-1800	5M	100-1800							
	H-10-107-30	200-4000			103SB	400-8000	8101531	200-3000	497661	5085-825	500-4000
	H-10-107-40	0.2-5%	5H	0.5-4%	103SA			0.1-3.0%			
Toluene	H-10-114-20	10-300	122	10-300	124SA	50-400	8101701	10-500	803947	5085-828	5-1000
Trichloroethylene	H-10-119-20	5-100	132M	5-100	134SA	5-150	6728541	20-250	487342	5085-842	20-250
Vinyl Chloride	H-10-128-10	1-20	131La	1-20	132SC	0.4-12	8101721	5-30	803950	5085-837	5-70
Water Vapor	H-10-120-10	2-10 lbs/MMCF	6LLP	2-10 lbs/MMCF	177UR	2-12 lbs/MMCF	6728531		488908	5085-851	1.4-9.1 lbs/MMCF†
	H-10-120-20	6-40 lbs/MMCF	6LP	6-40 lbs/MMCF	177UL	3-80 lbs/MMCF	8101321	6.4-128 lbs/MMCF‡			
	H-10-120-30	0.05-1 mg/L	6L	0.05-1 mg/L	177U	0.1-2 mg/L	8101321	0.1-1 mg/L			
Xylenes	H-10-112-20	10-200	123	10-250	143S	10-400	6733161	5-1000			

\* Units are ppmv unless noted.

‡ Actual scale on tubes is in mg/L, but is converted here to lbs/MMCF for ease of comparison.

## 7.5 Appendix 5. Conversion Factors for Gas Concentrations

To convert from the units on the left to the units on top, multiply by:

To: From:	Vol. %	ppmv	ppbv	mg/m3	mg/L
vol. %	-	104	107	$\frac{104(\text{mw.P})}{\text{MV}}$	$\frac{10(\text{mw.P})}{\text{MV}}$
ppmv	10-4	-	103	$\frac{(\text{mw.P})}{\text{MV}}$	$\frac{10-3(\text{mw.P})}{\text{MV}}$
ppbv	10-7	10-3	-	$\frac{10-3(\text{mw.P})}{\text{MV}}$	$\frac{10-6(\text{mw.P})}{\text{MV}}$
mg/m3	$\frac{10-4\text{MV}}{(\text{mw.P})}$	$\frac{\text{MV}}{(\text{mw.P})}$	$\frac{103\text{MV}}{(\text{mw.P})}$	-	10-3
mg/L	$\frac{0.1\text{MV}}{(\text{mw.P})}$	$\frac{103\text{MV}}{(\text{mw.P})}$	$\frac{106\text{MV}}{(\text{mw.P})}$	103	-

Key: P = pressure in atmospheres  
 MV = molar volume of gas (for air, see table below)  
 mw = molecular weight of compound in g/mole

1 Atmosphere Equivalents
1013 hPa
101.3 kPa
1.013 bar
1013 mbar
760 mm Hg
29.9 in. Hg
33.9 ft. H <sub>2</sub> O
14.7 psia

Temp. (°C)	Temp. (°F)	Air Molar Volume (MV)
-10	14	21.59
-5	23	22.00
0	32	22.41
5	41	22.82
10	50	23.23
15	59	23.64
20	68	24.05
25	77	24.46
30	86	24.87
35	95	25.28
40	104	25.69
45	113	26.10
50	122	26.51

## 7.6 Appendix 6. Humidity Conversion Tables

Dew Pt. or Temp.		mg/L	lbs/MMCF	ppmv at 25°C	%RH at 25°C	%RH at 20°C
°C	°F					
-85	-121	0.0005	0.03	0.7	0.002%	0.003%
-80	-112	0.0011	0.07	1.6	0.005%	0.007%
-75	-103	0.0025	0.15	3.4	0.011%	0.015%
-70	-94	0.005	0.31	6.9	0.02%	0.031%
-65	-85	0.010	0.62	13.5	0.04%	0.061%
-60	-76	0.019	1.17	25.6	0.08%	0.12%
-55	-67	0.034	2.14	46.8	0.15%	0.21%
-50	-58	0.061	3.80	82.8	0.26%	0.37%
-45	-49	0.10	6.52	142	0.45%	0.64%
-40	-40	0.17	10.9	238	0.76%	1.1%
-35	-31	0.29	17.8	388	1.2%	1.7%
-30	-22	0.45	28.3	617	2.0%	2.8%
-25	-13	0.71	44.0	960	3.1%	4.3%
-20	-4	1.1	67.1	1464	4.7%	6.6%
-15	5	1.6	100	2190	7.0%	9.9%
-10	14	2.4	148	3218	10%	14%
-5	23	3.4	213	4650	15%	21%
0	32	4.9	303	6615	21%	30%
5	41	6.8	425	9272	30%	42%
10	50	9.4	587	12816	41%	58%
15	59	12.9	801	17487	56%	79%
16	60.8	13.7	852	18581	59%	84%
17	62.6	14.5	904	19733	63%	89%
18	64.4	15.4	960	20947	67%	94%
19	66.2	16.3	1019	22225	71%	100%
20	68	17.3	1080	23569	75%	106%
21	69.8	18.4	1145	24984	80%	112%
22	71.6	19.5	1213	26471	84%	119%
23	73.4	20.6	1285	28034	89%	126%
24	75.2	21.8	1360	29677	95%	134%
25	77	23.1	1439	31401	100%	141%
26	78.8	24.4	1522	33211	106%	149%
27	80.6	25.8	1609	35111	112%	158%
28	82.4	27.3	1700	37103	118%	167%
29	84.2	28.8	1796	39192	125%	176%
30	86	30.4	1897	41381	132%	186%
31	87.8	32.1	2002	43674	139%	197%
32	89.6	33.9	2112	46075	147%	207%
33	91.4	35.7	2227	48589	155%	219%
34	93.2	37.7	2347	51219	163%	230%
35	95	39.7	2474	53971	172%	243%
40	104	51.3	3195	69707	222%	314%
45	113	65.6	4088	89203	284%	401%
50	122	83.2	5186	113153	360%	509%



## 7.7 Appendix 7. Limited Product Warranty

Honeywell warrants manual (hand-operated) pumps to be free of defects in workmanship for the life of use by the original owner. All other consumable items such as inlet filters, rubber inlets, plunger gaskets, which by their nature are consumed or depleted during normal operation, are excluded from this standard warranty.

Honeywell's obligation under this warranty is limited to replacing or repairing, at Honeywell's option, any defective or damaged part if returned to a Honeywell authorized factory repair center, with shipping charges prepaid by the buyer.

To maintain warranty, Purchaser must perform maintenance and calibration as prescribed in the Operation and Maintenance manual. In the event of a defect or damage, Purchaser will notify a Honeywell designated factory repair center in advance and if trouble diagnosis procedures are unable to determine and remedy the condition, a Return Material Authorization (RMA) will be issued to assure proper repair and logistics tracking.

Honeywell neither assumes nor authorizes any other firm or person to assume on Honeywell's behalf any liability in any way connected with the sale of Honeywell products.

Warranty does not extend to any equipment malfunction or damage that results from alteration, theft, misuse, abuse, abnormal use, or improper or unauthorized repairs.

This express warranty shall extend to buyer of record only and not to sales made by buyer's customers. Except for the warranty of title, the foregoing express warranty is in lieu of any and all other warranties, whether expressed or implied, including the implied warranties of fitness for a particular purpose and merchantability. Seller's liability under the warranty provided herein exclusive of insurance process shall be limited to a refund of purchase price.

## 7.8 Appendix 8. Honeywell Analytics Contacts

### North America and Latin America

#### Honeywell Analytics

405 Barclay Blvd.

Lincolnshire, IL USA 60069

Toll free: +1.888-749-8878

Fax: +1-817-274-8321

DetectGas@Honeywell.com

**Technical Support:** +1-847-955-8200

### Europe, Middle East, Africa and India

#### Life Safety Distribution AG

Javastrasse 2

8604 Hegnau

Switzerland

Tel: +41 (0)44 943 4300

Fax: +41 (0)44 943 4398

GasDetection@Honeywell.com

### Asia Pacific

#### Customer Business Centre

#701, Kolon Science Valley (1), 43 Digital-Ro

Guro-Gu, Seoul,

Korea

Tel: +82-2-69090300

Fax: +82-2-69090329

Analytics.ap@honeywell.com



# Honeywell Analytics Gas Detection Offerings

Honeywell Analytics gas detectors protect people, assets and environment from toxic and combustible gas hazards, helping to create safer, more comfortable, secure and productive environments. Our strength derives from Honeywell's leadership in sensor technology; in fact Honeywell operates four sensor manufacturing plants, supplying an entire industry with its core detective element.



## Portables

Single or multi-gas detectors ranging from compact, lightweight designs for personal protection to systems-based, networkable instrumentation for industrial hygiene.



## Commercial

Gas detection from standalone units to fully engineered, multi-point systems, all offering cost-effective regulatory compliance.



## Industrial

Renowned Sieger and Manning gas detection systems with advanced electrochemical, infrared and open path sensing technologies.



## High Tech/Government

Reliable gas and chemical detection including infrared spectroscopy (MST) with no cross interference, to Chemcassette paper-based solutions (MDA Scientific) offering detection down to parts per billion.

## Honeywell Analytics

405 Barclay Blvd.  
Lincolnshire, IL USA 60069  
Toll free: +1 888 749 8878  
Fax: +1 817 274 8321

DetectGas@honeywell.com  
www.honeywellanalytics.com

# Honeywell

H-010-4003-000

Rev: 03-2014

© 2014 Honeywell International

### Please Note:

While every effort has been made to ensure accuracy in this publication, no responsibility can be accepted for errors or omissions. Data may change, as well as legislation, and you are strongly advised to obtain copies of the most recently issued regulations, standards, and guidelines. This publication is not intended to form the basis of a contract.